

Issue 2023



made in Germany

megawood[®]

www.megawood.com

TECHNICAL BROCHURE

Important information
for specialty retailers.

megawood[®]
terrace Sustainable products
from the heart of Germany
naturally valuable



**GCC – A material
for generations**

Table of Contents

Table of Contents	2
List of items	3
Care instructions	13
Care tips – timeline	15
Colour development	16
Association of the German Wood-Based Panel Industry	17
Impregnation	18
Certificate indoor protect	19
Quality standards megawood® floorboards	20
Technical Information	21
General technical approval	22
Fraunhofer Institut for Mechanics of Materials	24
Test report - mould fungi	28
Safety information	32
Forms of delivery and packing units for decking	36
Certificate Cradle to Cradle	49
Certificate PEFC	50
Certificate Seal of Quality	52
Certificate solid boards - exemplary	53
Anti-slip properties test reports	54
Certificate classification of fire behavior	58
Marker for APP	64

LIST OF ITEMS

megawood® decking ^{GCC}HOLZart & ^{GCC}HARZart



megawood® decking				^{GCC} HOLZart	
Art. no.	Profile	Art. name	Colour	Length cm	H x W mm
NOVO070-300-600FE		CLASSIC	natural brown	300,360,420,480,540,600	21x145
NOVO071-300-600FE		CLASSIC	basalt grey	300,360,420,480,540,600	21x145
NOVO073-300-600FE		CLASSIC	nut brown	300,360,420,480,540,600	21x145
NOVO075-300-600FE		CLASSIC	slate grey	300,360,420,480,540,600	21x145
NOVO076-300-600FE		CLASSIC	lava brown	300,360,420,480,540,600	21x145
NOVO090-420-600FE		CLASSIC Jumbo	natural brown	420,480,600	21x242
NOVO091-420-600FE		CLASSIC Jumbo	basalt grey	420,480,600	21x242
NOVO093-420-600FE		CLASSIC Jumbo	nut brown	420,480,600	21x242
NOVO094-420-600FE		CLASSIC Jumbo	slate grey	420,480,600	21x242
NOVO095-420-600FE		CLASSIC Jumbo	lava brown	420,480,600	21x242
PS001-360-600FE		SIGNUM	muskat	360,420,480,540,600	21x145
PS002-360-600FE		SIGNUM	tonka	360,420,480,540,600	21x145
PJS090-360-600FE		SIGNUM Jumbo	muskat	360,420,480,540,600	21x242
PJS091-360-600FE		SIGNUM Jumbo	tonka	360,420,480,540,600	21x242
PD001-420-600FE		PREMIUM	natural brown	420,480,600	21x145
PD002-420-600FE		PREMIUM	basalt grey	420,480,600	21x145
PD003-420-600FE		PREMIUM	nut brown	420,480,600	21x145
PJ090-420-600FE		PREMIUM Jumbo	natural brown	420,480,600	21x242
PJ091-420-600FE		PREMIUM Jumbo (abZ)*	basalt grey	420,480,600	21x242
PJ093-420-600FE		PREMIUM Jumbo (abZ)*	nut brown	420,480,600	21x242
PD004-420-600FE		PREMIUM PLUS	slate grey	420,480,600	21x145
PD005-420-600FE		PREMIUM PLUS	lava brown	420,480,600	21x145
PJ094-420-600FE		PREMIUM PLUS Jumbo	slate grey	420,480,600	21x242
PJ095-420-600FE		PREMIUM PLUS Jumbo	lava brown	420,480,600	21x242



megawood® decking				^{GCC} HARZart	
Art. no.	Profile	Art. name	Colour	Length cm	H x W mm
MWDE021145VG420-600		DELTA	varia grey	420,480,600	21x145
MWDE021145VS420-600		DELTA	varia chocolate black	420,480,600	21x145
MWDE021145IN420-600		DELTA	ingwer	420,480,600	21x145
MWDE021145SG420-600		DELTA	sel gris	420,480,600	21x145
MWDE021145LO420-600		DELTA	lorbeer	420,480,600	21x145
MWCV021195VB420-600		CLASSIC Varia	varia brown	420,480,600	21x195
MWCV021195VG420-600		CLASSIC Varia	varia grey	420,480,600	21x195
MWCV021195VS420-600		CLASSIC Varia	varia chocolate black	420,480,600	21x195
DY110-420-600FE		DYNUM	cardamom	420,480,600	21x242
DY120-420-600FE		DYNUM	nigella	420,480,600	21x242
DY130-420-600FE		DYNUM	ingwer	420,480,600	21x242
DY140-420-600FE		DYNUM	sel gris	420,480,600	21x242
DY150-420-600FE		DYNUM	lorbeer	420,480,600	21x242
DY210-420-600FE		DYNUM (abZ)*	cardamom	420,480,600	25x293
DY220-420-600FE		DYNUM (abZ)*	nigella	420,480,600	25x293
DY230-420-600FE		DYNUM	ingwer	420,480,600	25x293
DY240-420-600FE		DYNUM	sel gris	420,480,600	25x293
DY250-420-600FE		DYNUM	lorbeer	420,480,600	25x293



* (abZ) General Building Approval.



LIST OF ITEMS



megawood® decking

megawood® sub construction			GCC HOLZart	
Art. no.	Profile	Art. name	Colour	LxWxH mm
NOVO004-360FE		Sub construction 40x60 mm	grey	3,600x60x40
MWUK080060GR400		Sub construction 80x60 mm	grey	4,000x60x80
KP010-360FE		Connector for sub construction 40x60 mm and sub construction 80x60 mm	grey	3,600x76x28

megawood® accessories sub construction				
Art. no.	Profile	Art. name	Colour	LxWxH mm
NOVO007-28		Sub construction fixing screws 92 mm TX30	galvanized	92x7.5
NOVO007-30		Sub construction fixing screws 132 mm TX30	galvanized	132x7.5
NOVO015-12		Self-adhesive retaining band 10 m/roll	black	10x12
NOVO017-21		Groove bridge, 20 pcs. for construction beams	V2A	55x10x8





megawood® VARIO FIX				
Art. no.	Profile	Art. name	Colour	LxWxH mm
MWVFUK100000SW		VARIO FIX I (40 - 143); with fixture for sub construction 40 x 60 mm and sub construction 80 x 60 mm	black	295x148x70
MWVFUK200000SW		VARIO FIX II (44 - 242) with fixture for sub construction 40 x 60 mm and sub construction 80 x 60 mm	black	295x148x70





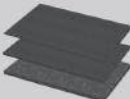

megawood® cleaning & accessories				
Art. no.	Profile	Art. name	Colour	LxWxH mm
MWDESP2UG000WE		Scouring powder , Quantity: 2000 g		85 x 138 x 350
MWDESR000000HO		Scrubbing brush		200 x 50 x 45
MWDEST000000HO		Scrubbing shaft; incl. holder and 2 wing screws		Stiel Ø32 1630x115x32

megawood® accessories impregnation for indoor use				
Art. no.	Profile	Art. name	Colour	LxWxH mm
NOVO016-113		megawood Indoor Protect 750 ml can		Ø10 x 120
NOVO016-112		megawood Indoor Protect 2.5L can		Ø14 x 190

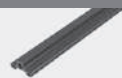
LIST OF ITEMS

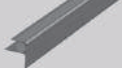
megawood® decking

megawood® accessories VARIO FIX				
Art. no.	Profile	Art. name	Colour	LxWxH mm
NOVO017-05		Attachment for elevated construction	black	79x58x63
NOVO017-07		Comfort pad for elevated construction	black	79x58x20
NOVO017-08		Assembly clip 10 pcs., without screws	V2A blackened	78x40x0
NOVO017-17		Rubber pad	black	300x300x3
NOVO017-18		Rubber pad	black	300x300x5
NOVO017-19		Rubber pad	black	300x300x10
NOVO017-20		Perforated tape 10 m roll	black	10,000x14x2
NOVO017-23		Screws for perforated tape M6x16 mm + washer + nut, 10 pieces	V2A	M6x16

megawood® accessories profiles and strips				
Art. no.	Profile	Art. name	Colour	LxWxH mm
NOVO017-14		Groove strip, 25 m/roll	black	21x12
NOVO017-15		Groove strip, 100 m/roll	black	21x12
MWNL00000007SW		Groove strip P5, 25 m/roll	black	25,000x11x5.5
MWNL00000008SW		Groove strip P5, 100 m/roll	black	100,000x11x5.5
MWLG105021ED200		Ventilation grilles Fastening: screw M6x40 mm	V2A	2,000x105x21
NOVO008-401		25 mm House connection profile, aluminium	silver	4,000x45x59
NOVO008-408		25 mm House connection profile, aluminium	anthrazit	4,000x45x59
NOVO008-402		21 mm House connection profile, aluminium	bronze	4,000x45x55
NOVO008-403		21 mm House connection profile, aluminium	silver	4,000x45x55
NOVO008-404		21 mm House connection profile, aluminium	anthrazit	4,000x45x55
NOVO008-405		Miter profile, aluminium	bronze	4,000x50x25
NOVO008-406		Miter profile, aluminium	silver	4,000x50x25
NOVO008-407		Miter profile, aluminium	anthrazit	4,000x50x25
NOVO007-21		Sealing tape for miter profile 20 mm, 13 m/roll		13,000x20x2



LIST OF ITEMS

megawood® decking

megawood® accessories decking assembly				
Art. no.	Profile	Art. name	Colour	LxWxH mm
NOVO017-0110		Locking clamp, one-piece, 50 pcs./pack	V2A	66 x 24 x 27
NOVO017-0111		Locking clamp, one-piece, 250 pcs./pack	blackened	66 x 24 x 27
NOVO007-0120		Locking clamp edge, one-piece, 25 pcs./pack	V2A blackened	66 x 18 x 27
NOVO007-011		Clip, 50 pcs./pack	V2A blackened	35 x 24 x 7,7
NOVO007-025		Clip, 250 pcs./pack		35 x 24 x 7,7
NOVO007-050		Clip, 500 pcs./pack		35 x 24 x 7,7
NOVO007-012		Edge clip, 25 pcs./pack		35 x 21 x 7,7
MWBFRK000000ST		Locking clamp, one-piece, 50 pcs./pack	normal steel	66 x 24 x 27
MWBFRK000025ST		Locking clamp, one-piece, 250 pcs./pack	blackened	66 x 24 x 27
MWBFRD000000ST		Locking clamp edge, one-piece, 25 pcs./pack	normal steel blackened	66 x 18 x 27
MWBFCLO00000ST		Clip, 50 pcs./pack	normal steel blackened	35 x 24 x 7,7
MWBFCLO00025ST		Clip, 250 pcs./pack		35 x 24 x 7,7
MWBFCLO00050ST		Clip, 500 pcs./pack		35 x 24 x 7,7
MWBFRLO00000ST		Edge clip, 25 pcs./pack		35 x 21 x 7,7
NOVO016-01		Rubber pad	black	100 x 60 x 20
NOVO016-11		Rubber pad	black	100 x 60 x 10
NOVO016-21		Rubber pad	black	100 x 60 x 3
NOVO007-013		Distance keeper, Mounting aid for decking	grey	60 x 16 x 20
NOVO007-014		Zammer Mounting aid for one-piece locking clamp		275 x 15 x 65
MWZUNL000009ED		Rolli, additional part for Zammer Mounting aid for groove strip P5		47 x 47 x 70
NOVO017-22		Screw M8 x 80 mm + washer + nut, 10 pieces	V2A	M8 x 80
MWBFRP000014ED		Screw M8 x 40 mm, 10 pieces/pack	V2A	M8 x 40
MWBFFP000011ED		Screw M6 x 40 mm, 10 pieces/pack	V2A	M6 x 40
NOVO007-05		Screw set 4 x 35 mm, 25 pieces/pack	V2A	4 x 35 mm
MWDHUK000006SW		Distanz Fix Spacers for heading joints	V2A blackened	162 x 54 x 20
MWBFFP000010SW		Arretier Fix for a height locking of the butt joints	V2A blackened	70 x 25 x 5

LIST OF ITEMS

megalite LED lighting system







megawood® accessories decking megalite LED lighting system				
Art. no.	Profile	Art. name	Colour	L x W x H mm
MWLL000021NW360		LED-Linear light horizontal, 3,600 mm, 27 W / 27lm/W = 729lm per Linear light	neutral white	3,600 x 62 x 21
MWLL000021NW480		LED-Linear light horizontal, 4,800 mm, 36 W / 27lm/W = 972lm per Linear light	neutral white	4,800 x 62 x 21
MWLL000021NW600		LED-Linear light horizontal, 6,000 mm, 45 W / 27lm/W = 1215lm per Linear light	neutral white	6,000 x 62 x 21
MWLL0000SRNW360		LED-Linear light vertical, 3,600 mm, 27 W / 27lm/W = 729lm per Linear light	neutral white	3,600 x 62 x 21
MWLL0000SRNW480		LED-Linear light vertical, 4,800 mm, 36 W / 27lm/W = 972lm per Linear light	neutral white	4,800 x 62 x 21
MWLL0000SRNW600		LED-Linear light vertical, 6,000 mm, 45 W / 27lm/W = 1215lm per Linear light	neutral white	6,000 x 62 x 21
MWSP000000NW034		LED-Spot Mini 34 mm, IP 67 24V DC (0,25 W/9 LED / 40lm/W = 10lm per Spot)	neutral white	Ø 34
MWSP000000NW060		LED-Spot Maxi, IP 67 24V DC (0,5 W/18 LED / 56lm/W = 28lm per Spot)	neutral white	Ø 60
MWNG00000040W24V		Power supply electronic ballast 24V DC IP 67, 40 W		270 x 30 x 17
MWNG0000000024V		Power supply electronic ballast 24V DC IP 67, 150 W		190 x 62 x 36,5
MWRP0000000024V		Repeater 24V IP 67, max. 72 W		160 x 79 x 55
MWFS0000000024V		Remote control set 24V IP 67, incl. remote, control, transmission capacity max. 72 W		200 x 79 x 55 184 x 28 x 21,5
MWVL000000SW100		Extension cables IP 68, 1,000 mm	black/blue	1,000 mm
MWVL000000SW300		Extension cables IP 68, 3,000 mm	black/blue	3,000 mm
MWVL000000SW600		Extension cables IP 68, 6,000 mm	black/blue	6,000 mm
MWVT000000SW002		Distributor 2-fold, IP 68	black/blue	75 x 17,5 x 40
MWVT000000SW004		Distributor 4-fold, IP 68	black/blue	145 x 17,5 x 40
MWLM000000NW360		LED bulb, 3,600 mm, (27 W / 27lm/W = 729lm per bulb)	neutral white	3,565 mm
MWLM000000NW480		LED bulb, 4,800 mm, (36 W / 27lm/W = 972lm per bulb)	neutral white	4,765 mm
MWLM000000NW600		LED bulb, 6,000 mm, (45 W / 27lm/W = 1215lm pro per bulb)	neutral white	5.965 mm
MWAP000021MW360		Cover profile horizontal, 3,600 mm	matte white	3,600 x 62 x 10
MWAP000021MW480		Cover profile horizontal, 4,800 mm	matte white	4,800 x 62 x 10
MWAP000021MW600		Cover profile horizontal, 6,000 mm	matte white	6,000 x 62 x 10
MWAP0000SRMW360		Cover profile vertical, 3,600 mm	matte white	3,600 x 62 x 21
MWAP0000SRMW480		Cover profile vertical, 4,800 mm	matte white	4,800 x 62 x 21
MWAP0000SRMW600		Cover profile vertical, 6,000 mm	matte white	6,000 x 62 x 21
MWPR000000AL360		Aluminium profile, 3,570 mm	aluminium	3,570 x 58 x 21
MWPR000000AL480		Aluminium profile, 4,770 mm	aluminium	4,770 x 58 x 21
MWPR000000AL600		Aluminium profile, 5,970 mm	aluminium	5.970 x 58 x 21
MWEK000000AL000		End caps for Linear light 2 pieces + 4 screws	aluminium	15 x 58 x 17



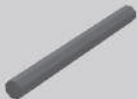

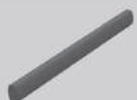
The LED linear luminaires contain a light source of energy efficiency classes E.
The LEDs can not be changed in the spotlight.

LIST OF ITEMS





LIMES fencing system







megawood® LIMES fencing system				gcc <i>HOLZart</i>	
Art. no.	Profile	Art. name	Colour	Length cm	H x W mm
MWPRO90090LA220		Circular posts	lava brown	220	Ø 90
MWPRO90090SC220		Circular posts	slate grey	220	Ø 90
MWPRO90090LA270		Circular posts	lava brown	270	Ø 90
MWPRO90090SC270		Circular posts	slate grey	270	Ø 90
MWP8090090LA220		Octagonal posts	lava brown	220	90 x 90
MWP8090090SC220		Octagonal posts	slate grey	220	90 x 90
MWP8090090LA270		Octagonal posts	lava brown	270	90 x 90
MWP8090090SC270		Octagonal posts	slate grey	270	90 x 90
MWP4090090LA220		Square posts	lava brown	220	90 x 90
MWP4090090SC220		Square posts	slate grey	220	90 x 90
MWP4090090LA270		Square posts	lava brown	270	90 x 90
MWP4090090SC270		Square posts	slate grey	270	90 x 90
MWPF060090LA220		Oval posts	lava brown	220	60 x 90
MWPF060090SC220		Oval posts	slate grey	220	60 x 90
MWPF060090LA270		Oval posts	lava brown	270	60 x 90
MWPF060090SC270		Oval posts	slate grey	270	60 x 90
MWKB040112LA179		Bar	lava brown	178,6	40 x 112
MWKB040112SC179		Bar	slate grey	178,6	40 x 112
MWPF060090LA179		Oval bar	lava brown	178,6	60 x 90
MWPF060090SC179		Oval bar	slate grey	178,6	60 x 90
MWBF038030LA157		H-shaped profile bar (8 units)	lava brown	156,6	38 x 30
MWBF038030SC157		H-shaped profile bar (8 units)	slate grey	156,6	38 x 30
MWBF038030LA179		H-shaped profile bar	lava brown	178,6	38 x 30
MWBF038030SC179		H-shaped profile bar	slate grey	178,6	38 x 30
MWBF038030LA190		H-shaped profile bar	lava brown	190	38 x 30
MWBF038030SC190		H-shaped profile bar	slate grey	190	38 x 30

megawood® LIMES fencing system				gcc <i>HARZart</i>	
Art. no.	Profile	Art. name	Colour	Length cm	H x W mm
MWPW270035IN160		Panel Augusta (wavy)	ingwer	160,2	270 x 35 x 6
MWPW270035SG160		Panel Augusta (wavy)	sel gris	160,2	270 x 35 x 6
MWPW270035LO160		Panel Augusta (wavy)	lorbeer	160,2	270 x 35 x 6
MWPW270035IN181		Panel Augusta (wavy)	ingwer	180,5	270 x 35 x 6
MWPW270035SG181		Panel Augusta (wavy)	sel gris	180,5	270 x 35 x 6
MWPW270035LO181		Panel Augusta (wavy)	lorbeer	180,5	270 x 35 x 6
MWPW270035IN210		Panel Augusta (wavy)	ingwer	210	270 x 35 x 6
MWPW270035SG210		Panel Augusta (wavy)	sel gris	210	270 x 35 x 6
MWPW270035LO210		Panel Augusta (wavy)	lorbeer	210	270 x 35 x 6
MWPG239006IN158			Panel Colonia (smooth)	ingwer	158,4
MWPG239006SG158	Panel Colonia (smooth)		sel gris	158,4	239 x 6
MWPG239006LO158	Panel Colonia (smooth)		lorbeer	158,4	239 x 6
MWPG239006IN210	Panel Colonia (smooth)		ingwer	210	239 x 6
MWPG239006SG210	Panel Colonia (smooth)		sel gris	210	239 x 6
MWPG239006LO210	Panel Colonia (smooth)		lorbeer	210	239 x 6
MWEW035177IN185		Fence set with stainless steel bar, comprising of:	ingwer	185	1,805 x 42
MWEW035177SG185		7 panels AUGUSTA (wavy) 1,805 mm	sel gris	185	1,805 x 42
MWEW035177LO185		2 stainless steel bars incl. post fastening 1,773 mm 1 insert bar for stainless steel bar 1,770 mm 1 accessories set for stainless steel bar	lorbeer	185	1,805 x 42

LIST OF ITEMS

LIMES fencing system & accessories

megawood® LIMES fencing system			GCC HARZart		
Art. no.	Profile	Art. name	Colour	Length cm	H x B mm
MWPH235025VG193		Panel Valeria	varia grey	193	25 x 235
MWPH235025VS193		Panel Valeria	varia chocolate black	193	25 x 235
MWPH235025IN193		Panel Valeria	ingwer	193	25 x 235
MWPN100100VG220		Post for panel Valeria	varia grey	220	100 x 100
MWPN100100VS220		Post for panel Valeria	varia chocolate black	220	100 x 100
MWPN100100IN220		Post for panel Valeria	ingwer	220	100 x 100
MWPN100100VG270		Post for panel Valeria	varia grey	270	100 x 100
MWPN100100VS270		Post for panel Valeria	varia chocolate black	270	100 x 100
MWPN100100IN270		Post for panel Valeria	ingwer	270	100 x 100
MWEL006034VG220		Insertion bar for Post Valeria	varia grey	220	6 x 34
MWEL006034VS220		Insertion bar for Post Valeria	varia chocolate black	220	6 x 34
MWEL006034IN220		Insertion bar for Post Valeria	ingwer	220	6 x 34
MWZUPF000001ED		Post cap for Post Valeria	V2A		Ø105

megawood® fencing system accessories				
Art. no.	Profile	Art. name	Colour	L x W x H mm
MWBFBK000001SW		Bar connectors; incl M6 x 30 mm screws; 4 units	blackened	85 x 35 x 11
MWBZPH00000ED		Panel holder; stainless steel, 14 units	stainless steel	32 x 32 x 34
MWBFPF000003ED		Base plate; incl. 4 units M8 x 80 mm screws	galvanized	140 x 120 x 10
MWBFHP000004ED		Pin; 10 units, 6 x 40 mm	stainless steel	105 x 96 x 57
MWBFHP000005ED		Internal hexagonal screw for H-shaped profile bar incl. bit, 16 units	stainless steel	M4 x 40
MWRI042060ED177		Stainless steel bar	stainless steel	1,773 x 60 x 42
MWEL019023GR177		Insert bar for stainless steel bar	grey	1,770 x 23 x 19
MWBFRI000012ED		Assessories set for stainless steel bar incl. post fastening (4 units + accessories)	stainless steel	95 x 45 x 50

Production-related measure tolerances megawood® LIMES fencing system		
		Tolerance zone
Panel length		+ - 2,0 mm

LIST OF ITEMS



Construction wood system

megawood® construction wood system			gcc <i>HOLZart</i>		
Art. no.	Profile	Art. name	Colour	Länge cm	H x W mm
KP004-360GRFE		Construction plank	basalt grey	360	40 x 112
KP005-360NUFE		Construction plank	nut brown	360	40 x 112
KP006-360BRFE		Construction plank	natural brown	360	40 x 112
KP009-360LBFE		Construction plank	lava brown	360	40 x 112
KP011-360SGFE		Construction plank	slate grey	360	40 x 112
MWKBO40112MU360		Construction plank	muskat	360	40 x 112
MWKBO40112TO360		Construction plank	tonka	360	40 x 112
KP012-420FE		Construction plank	natural brown	420	40 x 145
KP013-420FE		Construction plank	basalt grey	420	40 x 145
KP014-420FE		Construction plank	nut brown	420	40 x 145
KP015-420FE		Construction plank	lava brown	420	40 x 145
KP016-420FE		Construction plank	slate grey	420	40 x 145
MWKBO40145MU420		Construction plank	muskat	420	40 x 145
MWKBO40145TO420		Construction plank	tonka	420	40 x 145
MWKR090090LA360		Circular construction wood	lava brown	360	Ø 90
MWKR090090SC360		Circular construction wood	slate grey	360	Ø 90
MWK8090090LA360		Octagonal construction wood	lava brown	360	90 x 90
MWK8090090SC360		Octagonal construction wood	slate grey	360	90 x 90
MWK4090090LA360		Square construction wood	lava brown	360	90 x 90
MWK4090090SC360		Square construction wood	slate grey	360	90 x 90
MWKO090090LA360		Oval construction wood	lava brown	360	60 x 90
MWKO090090SC360		Oval construction wood	slate grey	360	60 x 90

megawood® construction wood system			gcc <i>HARZart</i>		
Art. no.	Profile	Art. name	Colour	Länge cm	H x W mm
MWKBO40112IN360		Construction plank	ingwer	360	40 x 112
MWKBO40112SG360		Construction plank	sel gris	360	40 x 112
MWKBO40112LO360		Construction plank	lorbeer	360	40 x 112
MWKBO40145IN420		Construction plank	ingwer	420	40 x 145
MWKBO40145SG420		Construction plank	sel gris	420	40 x 145
MWKBO40145LO420		Construction plank	lorbeer	420	40 x 145
MWRP021081NB420		Construction wood Rhombus	natural brown	420	20.5 x 81
MWRP021081NU420		Construction wood Rhombus	nut brown	420	20.5 x 81
MWRP021081VG420		Construction wood Rhombus	varia grey	420	20.5 x 81
MWRP021081VB420		Construction wood Rhombus	varia brown	420	20.5 x 81
MWRP021081VS420		Construction wood Rhombus	varia chocolate black	420	20.5 x 81
MWRP021081IN420		Construction wood Rhombus	ingwer	420	20.5 x 81
MWRP021081SG420		Construction wood Rhombus	sel gris	420	20.5 x 81
MWRP021081LO420		Construction wood Rhombus	lorbeer	420	20.5 x 81



LIST OF ITEMS

Construction wood system

megawood® accessories construction wood system				
Art. no.	Profile	Art. name	Colour	LxWxH mm
MWBFRP000001ED		Clamp for construction wood Rhombus 30 pcs./pack	stainless steel	40 x 83.6 x 15
MWBFRP000002SW		Clamp for construction wood Rhombus 30 pcs./pack	stainless steel blackened	40 x 83.6 x 15
MWBFRP000003ST		Clamp for construction wood Rhombus 30 pcs./pack	normal steel blackened	40 x 83.6 x 15

megawood® bench				
Art. no.	Profile	Art. name	Colour	LxWxH mm
FS020-205		Bench	natural brown	1,800 x 960 x 690
FS020-203		Bench	basalt grey	1,800 x 960 x 690
FS020-202		Bench	nut brown	1,800 x 960 x 690
FS020-206		Bench	lava brown	1,800 x 960 x 690
FS020-207		Bench	slate grey	1,800 x 960 x 690
FS020-208		Bench	ingwer	1,800 x 960 x 690
FS020-209		Bench	sel gris	1,800 x 960 x 690
FS020-210		Bench	lorbeer	1,800 x 960 x 690
FS020-211		Bench	muskat	1,800 x 960 x 690
FS020-212		Bench	tonka	1,800 x 960 x 690

megawood® plant container				
Art. no.	Profile	Art. name	Colour	LxWxH mm
MWPK110110LA081		Plant container	lava brown	1,000 x 1,000 x 810
MWPK110110SC081		Plant container	slate grey	1,000 x 1,000 x 810





megawood® sandpits				
Art. no.	Profile	Art. name	Colour	LxWxH mm
MWSK120120LA030		Sandpits 1x6-eck	lava brown	1,200 x 1,200 x 300
MWSK120120SC030		Sandpits 1x6-eck	slate grey	1,200 x 1,200 x 300
MWSK120210LA030		Sandpits 2x6-eck	lava brown	1,200 x 2,100 x 300
MWSK120210SC030		Sandpits 2x6-eck	slate grey	1,200 x 2,100 x 300
MWSK210210LA030		Sandpits 3x6-eck	lava brown	2,100 x 2,100 x 300
MWSK210210SC030		Sandpits 3x6-eck	slate grey	2,100 x 2,100 x 300

megawood® door				
Art. no.	Profile	Art. name	Colour	LxWxH mm
MWTR004102LA185		Door, no filling, incl. fittings	lava brown	1,020 x 40 x 1,850
MWTR004102SC185		Door, no filling, incl. fittings	slate grey	1,020 x 40 x 1,850

megawood® frame				
Art. no.	Profile	Art. name	Colour	LxWxH mm
MWZR040112LA270		Frame, comprising of construction planks	lava brown	1,120 x 145 x 1,850
MWZR040112SC270		Frame, comprising of construction planks	slate grey	1,120 x 145 x 1,850

LIST OF ITEMS

Assembly

megawood® LIMES standard section assembly				
Art. no.	Profile	Art. name	Colour	L x W x H mm
MWKONF0001		LIMES standard section assembly Consists of: Assembly of the bar connectors. Drilling of the holes for the panel holders.		
megawood® LIMES adapted section assembly				
Art. no.	Profile	Art. name	Colour	L x W x H mm
MWKONF0002		LIMES adapted section assembly Consists of: Reduction in the width/height of the elements and assembly of the bar connectors. Drilling of the holes for the panel holders.		
megawood® LIMES diagonal section assembly				
Art. no.	Profile	Art. name	Colour	L x W x H mm
MWKONF0003		LIMES diagonal section assembly Consists of: Diagonal sections and assembly of the bar connectors. Drilling of the holes for the panel holders.		
megawood® LIMES door assembly				
Art. no.	Profile	Art. name	Colour	L x W x H mm
MWKONF0004		Konfektion LIMES Tür Consists of: Assembly of the filling. Door elements are only supplied including infill. Please order the infill separately.		

CARE INSTRUCTIONS

What to do about stains and spots?

Comprehensive and extensive testing in our lab has yielded the following results:

We exposed our boards for bare feet to the most common types of soiling and staining. The results have shown that plain water, commonly used cleaning tools, and a little patience are the best solution with normal stains. After cleaning with plain water and several days of light exposure, most of the stains were no longer visible. Always avoid stains due to fine dusts (such as soot and metal dust). These may permanently stain your floorboards.

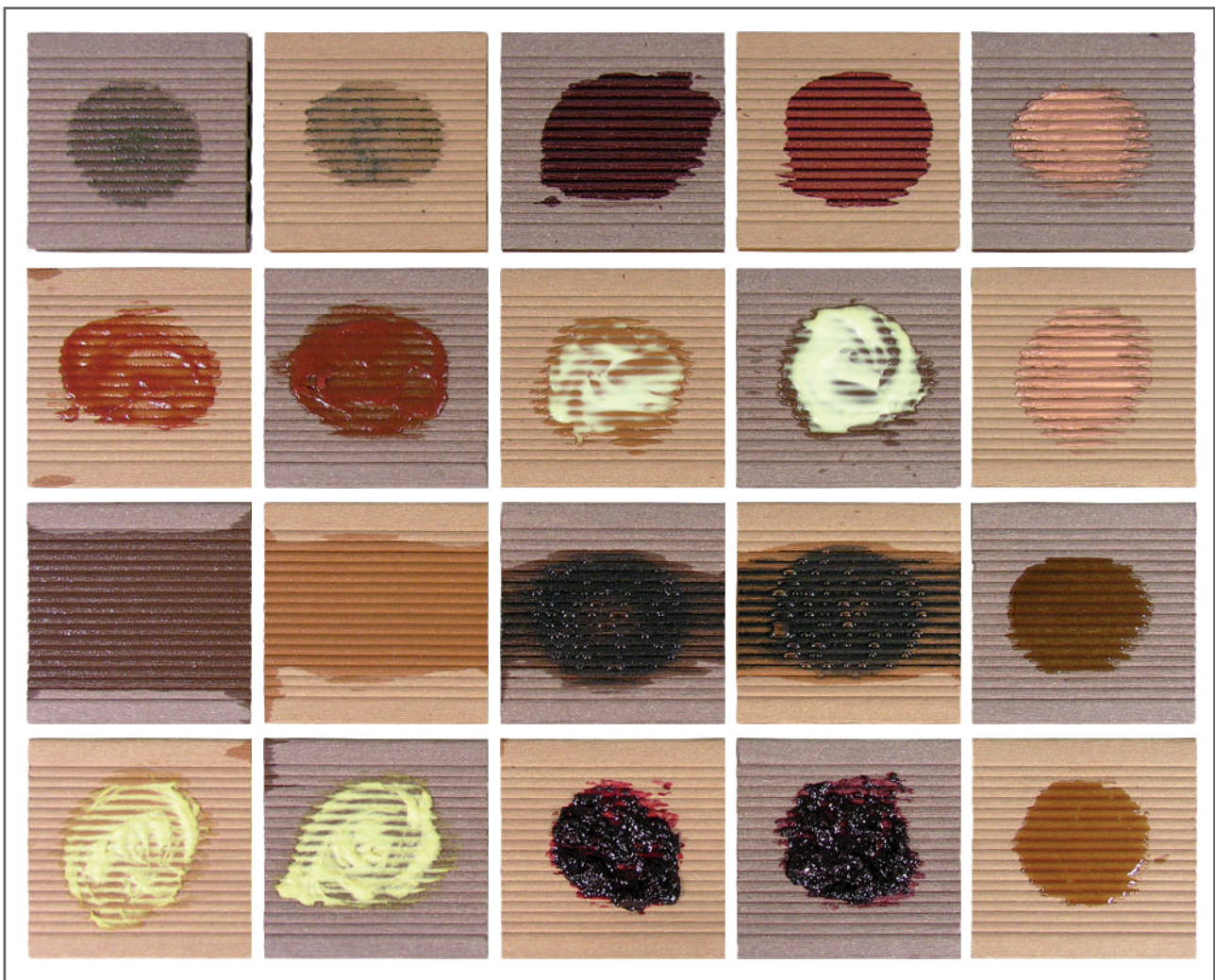

CARE INSTRUCTIONS



Naturally-occurring fibre content before treatment



Naturally-occurring fibre content after mechanical treatment with tools (e.g. Brass brush, chisel or by natural weathering)

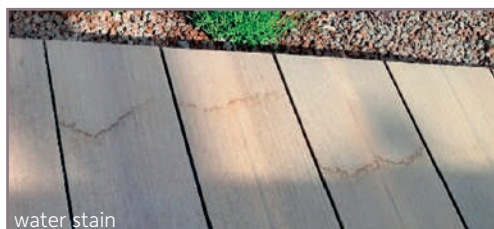

water stain

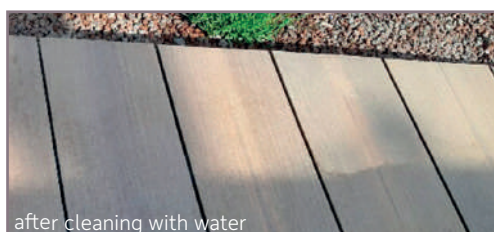

after cleaning with water



Scouring powder, 2 Kg bag

Naturally occurring bast fibre content

megawood® consists of up to 75 % wood fibre. This is specially treated, dried and added to the production process in a contained environment. The raw materials can contain small quantities of other natural fibres such as bast or skin fibre. These particles can rise to the surface due to water absorption through weathering.

This should not exceed a maximum of 0,03 % of the surface area, while the particles' size should not exceed 0,5 cm². These particles will dissolve over time through normal wear when the terrace is in use. They can also be removed mechanically with tools, without damaging the product.

Following the guidance of the EPLF (European Producers of Laminate Flooring), the accepted size of the particles is estimated from head height under direct vertical light.

Water stains

Partially covered terraces can be subjected to water stains in the transitional area between the covered and the uncovered area. Rainwater is flushed over the terrace surface to the cover before it dries off later. This subjects dust particles to temporary moisture before they dry off and remain on the surface. This effect occurs only slightly in the uncovered area which is permanently subjected to sun and rain and it is normally caused by the conditions on site. This does not impair the quality and is therefore not deemed to be a ground for complaint. The water stains can normally be removed using water and conventional cleaning devices.

This effect lessens in time but cannot be entirely avoided.

Scouring powder

for powerful cleaning of heavily soiled megawood® terrace surfaces. It is free of tensides and other chemicals and there is no danger to the ground water.



© 11499 0001

- ❖ 2 kg scouring powder are sufficient for approx. 20 sqm surface.
- ❖ Do not process sensitive surfaces or mask them beforehand.
- ❖ Do not use on GCC HARZart terrace decks!











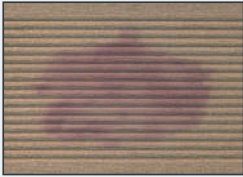

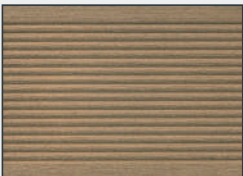
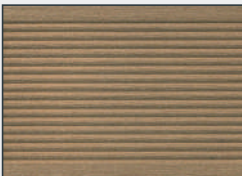

Important note for GCC HARZart floorboards!

For GCC HARZart planks with embossed or matt surface, use only water and a root brush. Do not use scouring powder or GCC/co-rundum scrubbers!

The safety data sheet and the list of ingredients can be found at: <https://www.novo-tech.de/service>

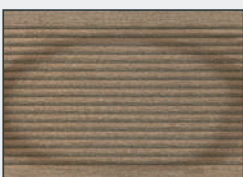
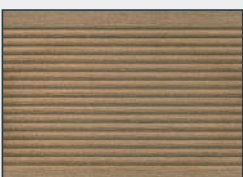
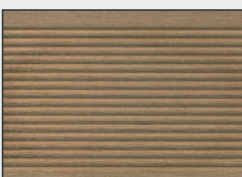
CARE TIPS

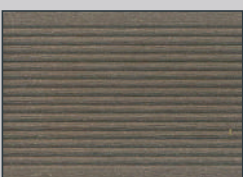
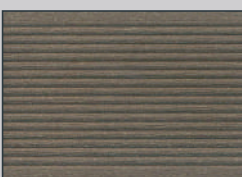
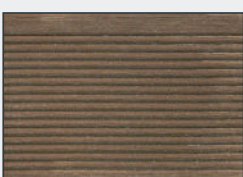
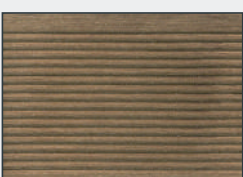
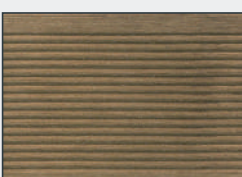
timeline

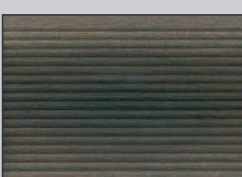
	Initial cleaning	7 days	14 days
Blackberry			
Coffee			
Mustard			
Ketchup			
Cream dressing			
Red wine			
Copper paste			
Soot, Oil			

COLOUR DEVELOPMENT

megawood® boards & visual protection elements

The very high dosing accuracy results in a very good homogeneity of the product. Our products are not produced in a discontinuous but a continuous process. The materials to be mixed are pressed into the mould using high pressure and a melt extruder. Rotating steel brushes are then used to remove the polymer surface that results in an optically textured wooden surface. The natural wood material contributes to our innovative product with its natural characteristics and properties.

The visible colour variations can be caused by the reactions of the lignin.

Once finished, the product starts out with a bright glossy hue. Please note that this is a natural product and as such is subject to colour maturation due to exposure to light, temperature, and air. The processed wood shaving darkens over the first week from a slightly yellowish glow to a deep, elegant colour hue. It is important that the floorboards for bare feet are installed in the direction of the grain (installation arrow) since the fibre orientation may otherwise result in a varying surface effect (lawnmower effect).

GCC
HOLZart



for CLASSIC and PREMIUM

for CLASSIC and PREMIUM

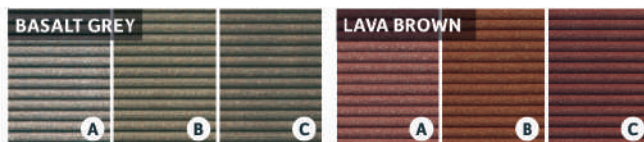

for CLASSIC and PREMIUM

for CLASSIC and PREMIUM PLUS



for CLASSIC and PREMIUM PLUS

for SIGNUM

for SIGNUM

A AFTER BEING INSTALLED

B DEPENDING ON INSOLATION 1-2 MONTH

C DEPENDING ON INSOLATION 6-8 MONTH

GCC
HARZart



for DYNUM

for DYNUM



for DELTA and DYNUM

for DELTA and DYNUM

for DELTA and DYNUM



for CLASSIC VARIA

for CLASSIC VARIA and DELTA

for CLASSIC VARIA and DELTA

The natural colour maturation is checked with accelerated weathering test and instruments. Sunlight and humidity is simulated with periodic changes; 1000 hours of weathering correspond with approx. one year of outdoor exposure. The quality of our products is checked daily. The product is not forwarded to the shipping department until the quality inspection is complete.

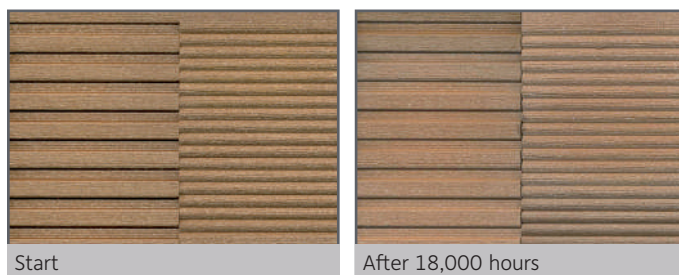



Environmental Product Declaration for WPC terrace floorboards and facade elements

An EPD (Environmental Product Declaration) is a multi-page document that describes the environmental impacts of building products based on an ecological assessment using quantitative data. The declaration is prepared by the manufacturer, tested at IBU (Institut Bauen und Umwelt e.V. [German Institute for Construction and Environment]) by independent verifiers based on the ISO 14025 and EN 15804 standards and is then subsequently published.

Environmental product declarations carry the information of the utilised building products that are required for a sustainability / environmental assessment on a building level. They contain information throughout the entire lifecycle, starting at the point of their manufacture, documentation of the base materials used for the product, the opportunities in terms of their processing and disposal as well as the detailed results of the product ecological assessments.

NOVO-TECH GmbH & Co. KG has also documented the environmental compatibility of its products by means of environmental product declarations (EPDs).



Together with the Association of the German Wood-Based Panel Industry, we are committed to sustainable construction by means of EPDs for WPC terrace floorboards and facade elements at IBU.

IMPREGNATION

for indoor use

With megawood® indoor protect, we have, for the first time, developed a product that now also permits a true indoor application of boards (such as conservatories) and protects your floorboards against staining. Soiling on megawood® floorboards installed outdoors does not represent a problem as the natural weathering, thanks to the fluctuation between sunlight (UV light) and watering (rain), breaks up the organic compounds and ensures that the patches more or less disappear within a few days or weeks.

This weathering effect is not especially pronounced indoors. Only a slight application of megawood® indoor protect is required in order to achieve the desired effect. Furthermore, the colour of your terrace becomes more intense and a harmonious, natural wood appearance is achieved.

Please note that the impregnation may only take place on clean floorboards and should also be repeated where necessary. We recommend treating the decking prior to the first use.

The maintenance product is thinly and evenly applied to smooth surfaces using a sponge or cloth and is subsequently wiped away using a dry, soft textile cloth so that the excess indoor protect is fully removed.

The maintenance product is thinly and evenly applied to profiled surfaces using a brush and is subsequently wiped away using a dry, soft textile cloth so that the excess indoor protect is fully removed.



Application for PREMIUM and PREMIUM PLUS boards



Application for CLASSIC boards

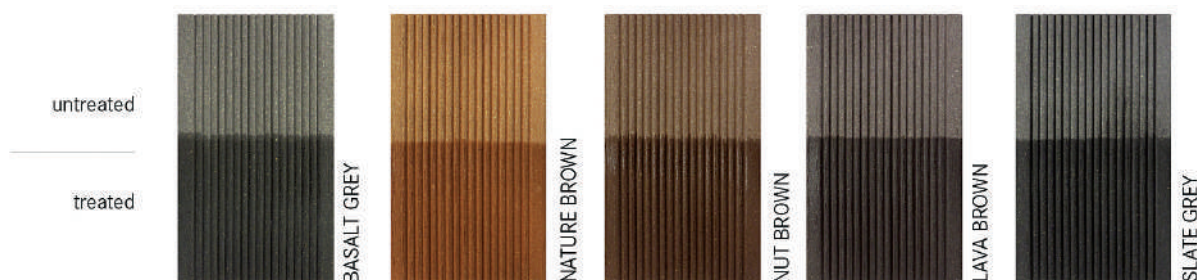

CERTIFICATE

Indoor Protect



akkreditiert durch die Deutsche Akkreditierungsstelle GmbH (DAkkS)

P R Ü F U N G S Z E U G N I S

CT-14-06-23-3

Produkt: PNZ Megawood Indoor Protector

Firma: PNZ Produkte GmbH
Eichstätter Straße 2-4a
85110 Kipfenberg

Auftrag: Bestimmung ausgewählter Oberflächeneigenschaften

Prüfmethodik: Bestimmung des Migrationsverhaltens von Schwermetallen nach DIN EN 71-3 (2013:07)

Prüfbericht: 2514261 vom 02. Juni 2014

Prüfergebnis: *Migrationsverhalten*

Das getestete Produkt hält die Anforderungen an die Konzentrationen eluierbarer Schwermetalle Aluminium (Al), Antimon (Sb), Arsen (As), Barium (Ba), Bor (B), Cadmium (Cd), Kobalt (Co), Chrom (Cr), Kupfer (Cu), Quecksilber (Hg), Mangan (Mn), Nickel (Ni), Blei (Pb), Selen (Se), Zinn (Sn), Strontium (Sr) und Zink (Zn) entsprechend DIN EN 71-3 (2013:07) Klasse III vollständig ein.

Dresden, 23.Juni2014

Leiter des Prüflaboratoriums



verantwortlicher Bearbeiter

QUALITY STANDARDS

megawood® boards

1. Mechanical characteristics boards CLASSIC, CLASSIC Varia, SIGNUM, PREMIUM, PREMIUM Plus, DYNUM und DELTA

Three-point bending sc 40x60 mm:

Bearing distancer: 440 mm
 Centre distance: 500 mm
 Test speed: 20 mm/min
 Breaking load: mind. 3.400 N*

Three-point bending sc 80x60 mm:

Bearing distancer: 440 mm
 Centre distance: 500 mm
 Test speed: 20 mm/min
 Breaking load: mind. 3.400 N*

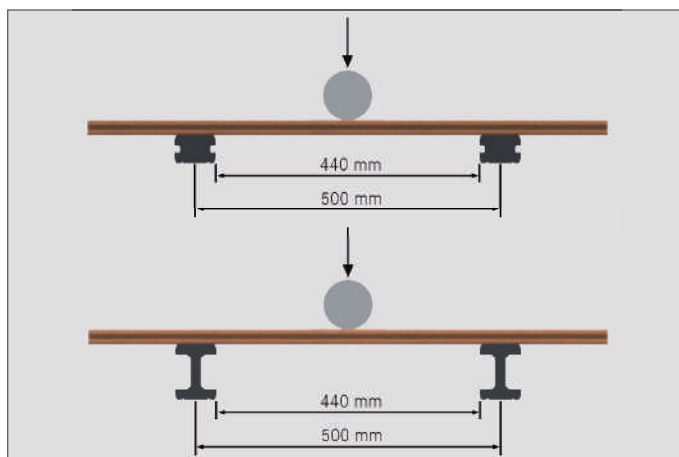

* 3,400 N equals \approx 340 kg/board at a maximum distance of 50 cm between the supporting beams.

3. Mechanical characteristics construction plank 40x112 mm

Three-point bending:

Bearing distancer: 960 mm
 Centre distance: 1,000 mm
 Test speed: 20 mm/min
 Breaking load: min. 3,400 N*

* 3,400 N equals \approx 340 kg/board at a maximum distance of 100 cm between the supporting beams.

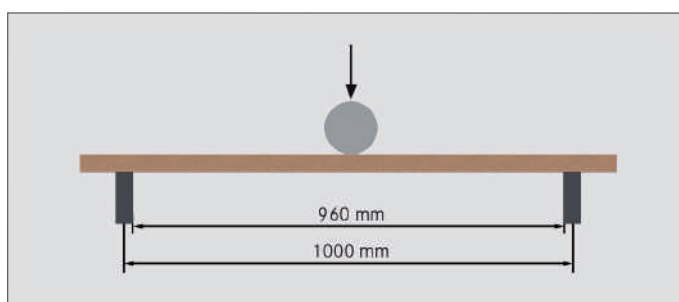

4. Mechanical characteristics construction plank 40x145 mm

Three-point bending:

Bearing distancer: 1,160 mm
 Centre distance: 1,200 mm
 Test speed: 20 mm/min
 Breaking load: min. 3,400 N*

* 3,400 N equals \approx 340 kg/board at a maximum distance of 120 cm between the supporting beams.

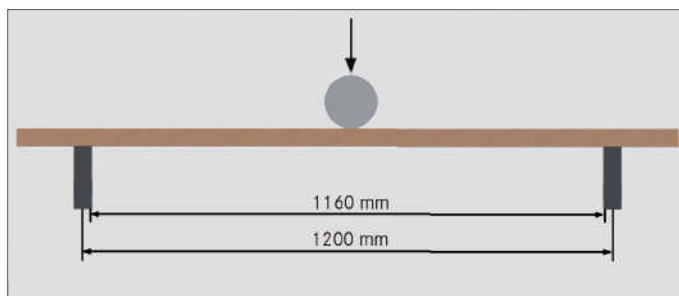

5. Permissible dimension change after water absorption

Permissible dimension change after water absorption* megawood® boards

Dimension	Measuring point	Permissible dimension change Guaranteed values	Notes
Length	Maximum value	Board length 300 cm	≤ 9.0 mm
		Board length 360 cm	≤ 10.8 mm
		Board length 420 cm	≤ 12.6 mm
		Board length 480 cm	≤ 14.4 mm
		Board length 540 cm	≤ 16.2 mm
		Board length 600 cm	≤ 18.0 mm
			$\leq (3 \text{ mm/m})$
Width (max. 295 mm)	Middle of board		max. ≤ 0.9 mm
Thickness (max. 25 mm)	Middle of board		max. ≤ 0.5 mm

Pay attention to distances of fixed component parts

* with outdoor exposure and installation acc. to assembly instructions

TECHNICAL INFORMATION

megawood® boards

megawood® board and Bangkirai

Abrasion resistance comparison test

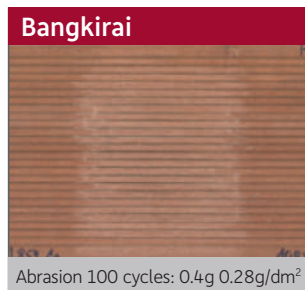

Abrasion resistance test conditions

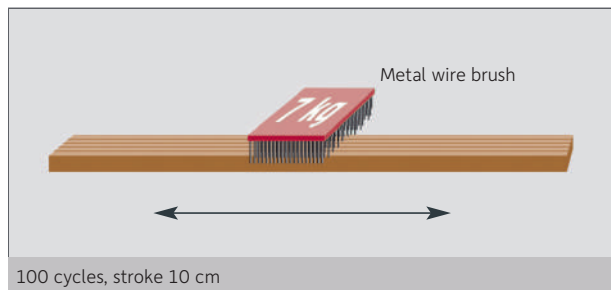

Material description

megawood® is a polymer-bonded wood material and contains of up to 75 % wood fibres, high-value polymers, suitable additives and colorants.

Distinctive characteristics and advantages

- High resistance against external environmental impacts
- Easy to work with same as normal wood
- Installed with clamp system
- Environment-friendly and recyclable
- Up to 75 % renewable raw materials
- Dyed throughout and surface-ready
- Resistant to mould fungus
- IHD-Standard 20-25 (2006)

Technical data				
Characteristics		Measuring unit	megawood® ₁	Quality seal class ₂
Density		g/cm ³	> 1.3	
Breaking strength*)		N	≥ 4,000	≥ 3,300
Bending at 500 N		mm	≤ 1.8	≤ 1.9
Swelling after cold water storage (28 days)	Volume	Weight %	≤ 2.0	≤ 7.0
	Lengthwise	%	≤ 0.3	≤ 0.4
	Width	%	≤ 0.3	≤ 0.8
	Thickness	%	≤ 1.7	≤ 4.0
Skid resistance	Slip class		min. R 10	min. R 10
Thermal flexural behaviour		mm	Δs ≤ 10	Δs ≤ 10
Behaviour during the freeze-thaw test	Breaking load	Δ %	≤ 20	≤ 20
Thermal expansion coefficient		10 ⁻⁶ / K	20	≤ 40

These values have been determined with test specimens and may vary depending on production. They are therefore only approximate values.

*) This value applies to single floorboard upon centre distance between support points (mid of support) of 50 cm!

1) Static mean values for megawood® boards. Individual data sheets per plank can be requested separately.

2) Static mean values for achieving the quality seal, conform to the EU Safety Standard EN 15534-1 and the EU product standard EN 15534-4.

Production-related measure tolerances megawood® boards

	Specifications	Tolerance zone
Profile length	300, 360, 420, 480, 540, 600 cm	-0,0 / + 10,0 mm
Profile width	145 mm, 195 mm, 242 mm, 293 mm	-2,0 / + 1,0 mm
Profile thickness	21 mm, 25 mm	-1,0 / + 1,0 mm
Flatness surface profile DELTA		-0,5 / + 1,0 mm

QUALITY STANDARDS

General Building Approval (abZ)

In accordance with the General Building Approval (abZ), the **DYNAM 25 x 293 mm (Cardamom & Nigella)** and **PREMIUM Jumbo 21 x 242 mm (nut brown & basalt grey)** terrace boards can be used as a load-bearing floor for roof terraces, pergolas, loggias, balconies, escape landings, catwalks and similar in addition to stairs and stair landings in residential buildings and office buildings conform with the DIN EN 1991-1-1/NA1 standard, Table 6.1 DE, Categories T1, T2 und Z. The bearing floor is to be at least a multi-field support (at least a two-field support) and it is to be installed so that the terrace boards are visible and can always be replaced.

The terrace boards are only to be laid and mounted by companies that have the necessary experience. The bearing substructure is to be of wood or steel. The terrace boards are to be mounted on each of the supports on both of the longitudinal sides by them being placed on the wood or steel substructure and then fixed in place using a stainless steel clip and screw. Only terrace boards with a full width are to be laid and a cutting to size along the longitudinal edge is not permitted. No damaged terrace boards are to be mounted. The terrace boards can be laid in the direction of the span (in a longitudinal direction of the board) with a gradient of max. 2%. The drilling of holes or the creating of break-throughs in the terrace boards is basically not permitted.

1. Laying the PREMIUM Jumbo terrace boards on a wood or steel structure

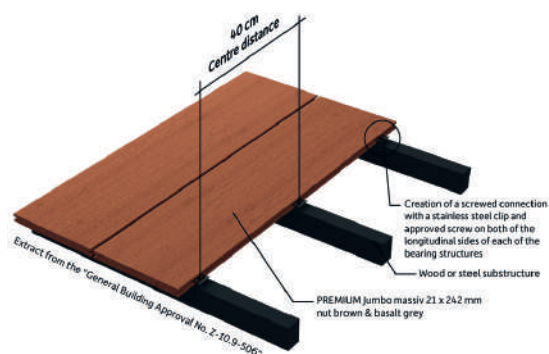

Three-point bending:

Centre distance: 400 mm
 Breaking load: min. 9,100 N*

* 9,100 N equals \approx 910 kg/board at a maximum distance of 40 cm between the supporting beams.

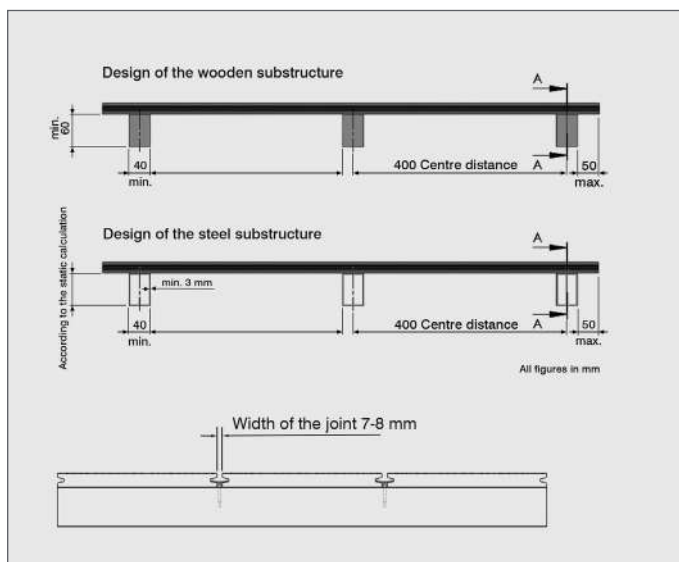

2. Laying the DYNAM terrace boards on a wood or steel structure

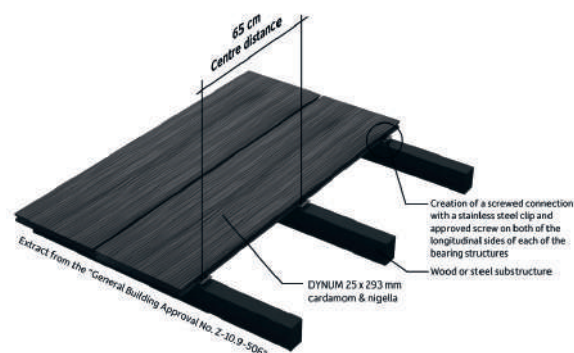

Three-point bending:

Centre distance: 650 mm
 Breaking load: min. 8,500 N*

* 8,500 N equals \approx 850 kg/board at a maximum distance of 65 cm between the supporting beams.

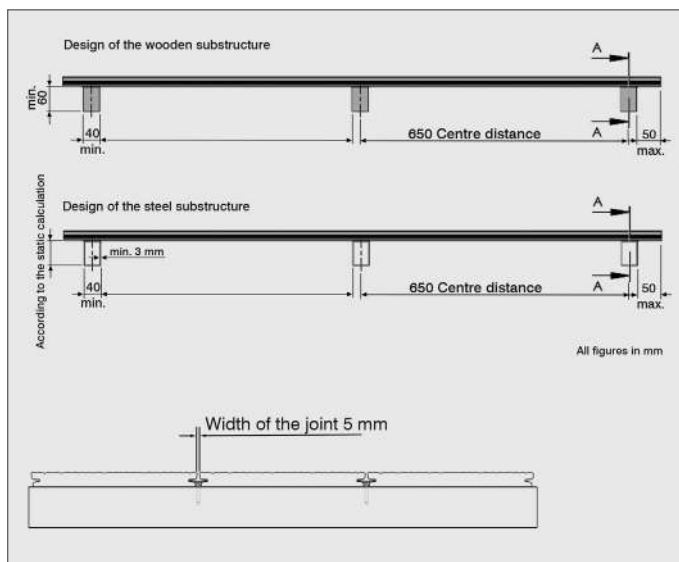

CERTIFICATE

General Building Approval (abZ)

Deutsches
Institut
für
Bautechnik

DIBt

**Allgemeine
bauaufsichtliche
Zulassung/
Allgemeine
Bauartgenehmigung**

Zulassungsstelle für Bauprodukte und Bauarten

Bautechnisches Prüfamts

Eine vom Bund und den Ländern
gemeinsam getragene Anstalt des öffentlichen Rechts

Mitglied der EOTA, der UEAtc und der WFTAO

Datum:

21.09.2020

Geschäftszeichen:

I 71-1.10.9-506/2

Nummer:

Z-10.9-506

Geltungsdauer

vom: **21. September 2020**

bis: **21. September 2025**

Antragsteller:

NOVO-TECH GmbH & Co. KG

Siemensstraße 31

06449 Aschersleben

Gegenstand dieses Bescheides:

Barfußdielen "megawood" Typ "PREMIUM Jumbo massiv 21x242 mm" und
"DYNUM massiv 25x293 mm" aus Holz-Polymer-Verbundwerkstoff für tragende Böden

Der oben genannte Regelungsgegenstand wird hiermit allgemein bauaufsichtlich zugelassen und
genehmigt.

Dieser Bescheid umfasst neun Seiten und vier Anlagen mit 10 Seiten.

DIBt

DIBt | Kolonnenstraße 30 B | D-10829 Berlin | Tel.: +49 30 78730-0 | Fax: +49 30 78730-320 | E-Mail: dibt@dibt.de | www.dibt.de

TEST REPORT

Fraunhofer Institut for Mechanics of Materials



Fraunhofer Institut
Werkstoffmechanik

Fraunhofer IWM Heideallee 19 06120 Halle

Novo-Tech GmbH & CoKG
Mr. Sasse

Institutsleiter
Prof. Dr. Peter Gumbsch

Heideallee 19
066120 Halle

Wöhlerstraße 11
79108 Freiburg

Telefon +49 (0) 345/55 89-0
Telefax +49 (0) 345/55 89-1 01
www.iwmh.fraunhofer.de

Steffen Meinicke
Telefon +49 (0) 3 45/55 89-436
Telefax +49 (0) 3 45/55 89-1 01
Steffen.Meinicke@iwmh.fraunhofer.de

Halle, 15.03.2006

Test report

Dear Mr. Sasse,

below you can find your floorboard characteristic values (samples taken from production dated 26.01.2006 and 28.01.2006) determined in-house by our company.

1. Determination of thermal expansion coefficient

The determination of the thermal coefficient has been carried out acc. to DIN EN 13471. The determination of the characteristic values has three directions using a non-contact measuring system. The measurement has been executed within a temperature range of 25°C to 80°C.

The expansion has been measured at the profile surface in length (extrusion direction) and width (laterally to extrusion direction), as well as the profile cross-section width and thickness [depth] of profile).

Vorstand der Fraunhofer-Gesellschaft
Univ.-Prof. Dr. ing. habil. Prof. e.h. Dr. h.c.
Hans-Jörg Bullinger, Präsident
Dr. rer. pol. Alfred Gossner
Dr. jur. Dirk-Meints Polter
Prof. Dr. Dennis Tsichritzis

Fraunhofer-Gesellschaft zur Förderung
der angewandten Forschung e.V. München

Bankverbindung: Deutsche Bank, München
Konto 7521933 BLZ 700 700 10
IBAN: DE86 7007 0010 0752 1933 00.
BIC (Swift-Code): DEUTDFMM

TEST REPORT

Fraunhofer Institut for Mechanics of Materials

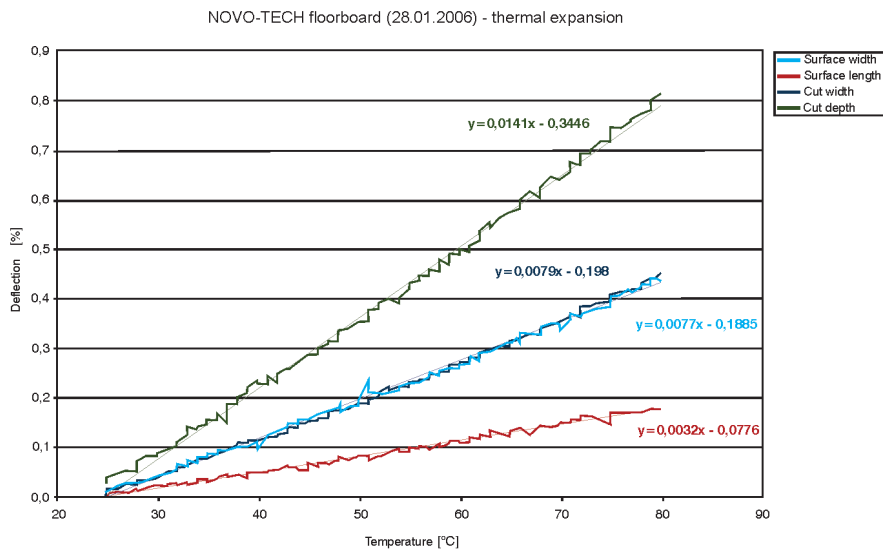

2. Determination of water absorption and thickness swelling

Determination of thickness swelling after water absorption following DIN EN 317 has been carried out with test specimens prepared from the component part (profile with 145 mm length). The samples have been stored in resting water (pH-value 7 +/- 1) at (20 +/- 2)° C. The swelling measurement is taken at the following times: 1d, 7d, 14d, 28d, 42d. The water absorption is determined gravimetrically (times same as with swelling).

[d]	Floorboard 26.01. [mm]		water absorption [%]
	l	b	
0	145.02	145.58	0.0
1	145.05	145.70	0.9
7	145.16	145.89	2.9
14	145.45	146.15	4.3
21	145.39	146.19	5.2
28	145.49	146.42	5.9
40	145.68	146.72	7.1

[d]	Floorboard 28.01. [mm]		water absorption [%]
	l	b	
0	145.15	145.41	0.0
1	145.10	145.45	1.0
7	145.25	145.65	2.9
14	145.35	145.78	4.4
21	145.41	145.91	5.3
28	145.47	146.09	5.8
40	145.51	146.30	7.0

TEST REPORT

Fraunhofer Institut for Mechanics of Materials

3. Determination of bending creep behaviour at increased temperature

The creep behaviour has been determined according to DIN ISO 899-2 using a bending creep test with a three-point bending procedure. The measurement has been executed in a climatic chamber. The test has been carried out within a period of 150 hours and at 50° C as well as 50% r.H. The support distance was 440 mm. The samples have been impinged with a constant load of 100 kg. The following table lists the test results.

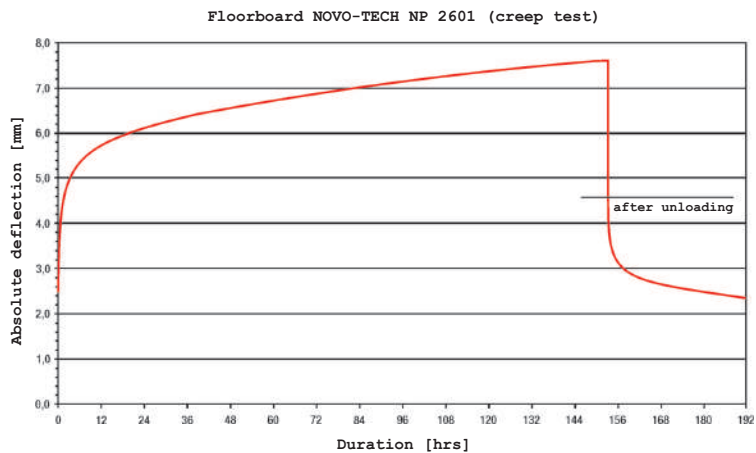
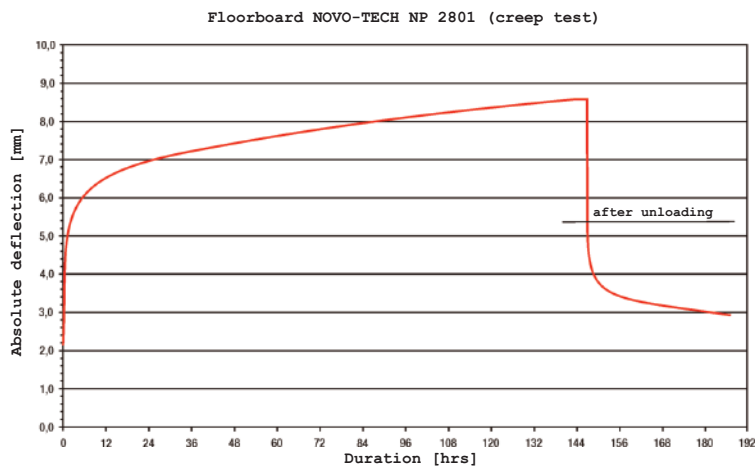

TEST REPORT

Fraunhofer Institut for Mechanics of Materials

4. Determination of E modulus in 3-point bending test

To determine the E-modulus, breaking strength and maximum deflection, a 3-point test with a support distance of 440 mm has been conducted with profiled parts 550-mm in length.

Sample	E-modulus [N/mm ²]	max. strength [N]	max. deflection [mm]
26.01.2006	3576	3643	14
28.01.2006	3392	3514	14
14.02.2006	3489	3544	26
15.02.2006	3467	3570	26

If there are any questions concerning this test report, please do not hesitate to contact me.

Sincerely yours

Steffen Meinicke

TEST REPORT

225 009

1. Test of resistance to mould fungi

1.1 Test information

Test principle:

Shaped test specimens have been exposed to mould fungi attack by inoculating defined mixture of spores. Because test material is intended for outdoor use, one portion of test specimens was put to strain by washing-out prior to biological test. In order to simulate nutrient dragging by pollution in practise, testing additionally has been executed under intensified conditions, i.e. by adding a nutrient solution. The test formulations have been incubated for four weeks under conditions that support growing and germinating of mould fungi. The evaluation of mould fungi vegetation as test criterion has been carried out after 7, 14 and 28 days according to defined bonitation key.

Test variants:

- Standard test without nutrient solution without aging
- Standard test without nutrient solution and strain of washing-out
- Intensified test with nutrient solution without aging
- Intensified test with nutrient solution and strain of washing-out

Underlying test procedure:

The test has been carried out in accordance with IHD Standard [Institute for Wood Technology Dresden] 20-25 (2006): "Test of resistance to mould fungi of construction and wood materials" based on EN 60068-2-10:2005 "Environmental influences - Parts 2-10: Test procedures - Test J and guideline: mould growth" (IEC 60068-2-10:2005).

Tested fungi:

Aspergillus niger, Paecilomyces variotii, Penicillium funiculosum, Trichoderma viride, Chaetomium globosum

Cultivation conditions:

28 days' incubation in incubator at 29°C and 95 % relative air humidity

Sterilisation procedure:

Pressure cooker (100°C, 2 x)

Aging strain prior to test:

Saturation without vacuum during 7 days with 6 times water exchange (following DIN EN 84)

Test specimen dimensions:

Test material: 50x20x5 mm³

Reference material: 50x25x15 mm³ (pine splint), 60x60x20 mm³ (MDF)

Date of test specimen installation / removal:

26.01.2006 / 23.02.2006

TEST REPORT

225 009

1.2 Results

Table 3: Test **without prior strain of washing-out**:

Vegetation on test specimen top surface after 28 days (Average values each time from 6 individual values)

No.	Material	Average rating number			
		External infection		Self infection	
		Standard-test	Intensified test	Standard-test	Intensified test
1)	WPC H40-05, grey	1	1	1	1
2)	WPC H41-05, brown	1	1	1	1
3)	Bangkirai	1	3	1	3

Table 4: Test **after prior strain of washing-out**:

Vegetation on test specimen top surface after 28 days (Average values each time from 6 individual values)

No.	Material	Average rating number			
		External infection		Self infection	
		Standard-test	Intensified test	Standard-test	Intensified test
1)	WPC H40-05, grey	1	1	1	1
2)	WPC H41-05, brown	1	1	1	1
3)	Bangkirai	1	3	1	3

Evaluation scheme:

0 No mould fungi detectable on the test specimen surface upon examination under reflected-light microscope at 50-fold enlargement.

2 Mould fungi vegetation clearly detectable with unaided eye and clearly lower than on comparison test specimen.

1 Mould fungi not or barely detectable with unaided eye; however, clearly at 50-fold enlargement detectable.

3 Mould fungi vegetation clearly detectable with unaided eye and equal to or stronger than on comparison test specimen.

Table 5: Wood humidity after test **without prior strain of washing-out**

(average values each time from 6 individual values)

No.	Material	Average rating number			
		External infection		Self infection	
		Standard-test	Intensified test with nutrient solution	Standard-test	Intensified test with nutrient solution
1)	WPC H40-05, grey	13.7	13.3	12.0	13.1
2)	WPC H41-05, brown	12.0	11.7	11.4	12.1
3)	Bangkirai	21.6	21.3	19.3	20.2
4)	Ref. pine splint	26.9	27.4	26.8	27.0
5)	Ref. light MDF	26.4	26.2	29.2	25.1

TEST REPORT

225 009

Table 6: Wood humidity after test **with prior strain of washing-out**
(average values each time from 6 individual values)

No.	Material	Average rating number			
		External infection		Self infection	
		Standard-test	Intensified test with nutrient solution	Standard-test	Intensified test with nutrient solution
1)	WPC H40-05, grey	13.7	14.9	13.5	12.6
2)	WPC H41-05, brown	13.1	12.7	12.1	12.3
3)	Bangkirai	21.7	20.9	20.4	21.6
4)	Ref. pine splint	27.2	27.6	27.1	27.4
5)	Ref. light MDF	25.3	26.3	26.9	27.6

1.5 Evaluation / summary

As a result of structure and colour of WPC material, mould fungi vegetation was not detectable with unaided eyes (Fig. 3). Inspection under reflected-light microscope, however, has provided evidence, that mould fungi were grown on tested variants "H40-05" and "H41-05" (Fig. 5 to 11), but at a clearly lower level than on both comparison test specimens from MDF and pine splint. The vegetation on Bangkirai was low with standard tests and strong with intensified test conditions when additional nutrients were supplied. The strain of washing-out on WPC and Bangkirai had no significant influence on resistance to mould fungi.

Evaluation of resistance to mould fungi is based on following scheme:

(IHD works standard VA20-25):

Bonitation level	Field of application	
	Internal area ¹⁾	External area ²⁾
0	resistant	resistant
1	reduced resistant	resistant
2	not resistant	reduced resistant
3	not resistant	not resistant

¹⁾ All areas, where material is in contact with room air of restrooms

²⁾ All areas, which do not comply with internal area's definition

Because the tested materials are terrace covering for external area, result of test variant "Intensified Test with strain of washing-out" will be used for final evaluation: According to that, WPC variants "H40-05" and "H41-05" have proved resistant to mould fungi for outdoor use, however, Bangkirai by contrast was not resistant.



Katharina Plaschkies, Master's in Biology

Responsible person in charge

Dresden, 28.02.2006

TEST REPORT

225 009

1.4 Photos

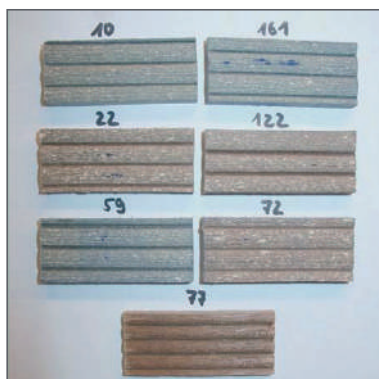

Fig. 3: Selected test specimen after mould fungi test: no vegetation macroscopically detectable



Fig. 4: Reference test specimen after mould fungi test: vegetation clearly detectable (above: MDF, below: pine splint)



Fig. 5: Mould fungi on test specimen 10 (H40), 40-fold enlargement

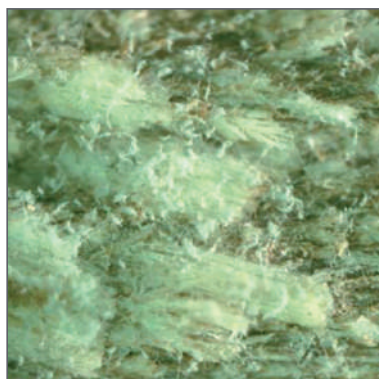

Fig. 6: Mould fungi on test specimen 22 (H41), 40-fold enlargement



Fig. 7: Mould fungi on test specimen 59 (H40), 40-fold enlargement

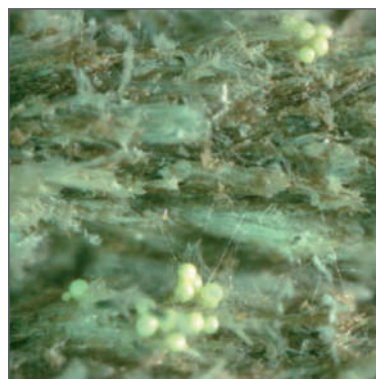

Fig. 8: Mould fungi on test specimen 72 (H41), 70-fold enlargement



Fig. 9: Mould fungi on test specimen 77 (Bangkirai), 50-fold enlargement

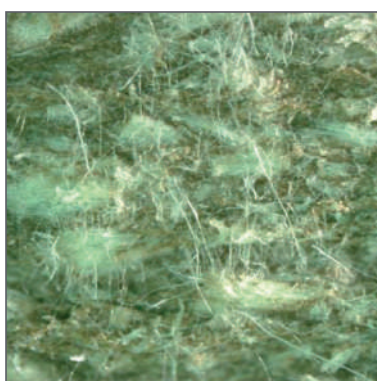

Fig. 10: Mould fungi on test specimen 122 (H41), 40-fold enlargement



Fig. 11: Mould fungi on test specimen 161 (H40), 40-fold enlargement

TECHNICAL SAFETY INFORMATION HOLZART

1.) Material/Manufacturer Designation

Product designation:	megawood®
Material/substance type:	Polymer bonded wood material
Use:	Production of extruded profiles and injection moulding elements
Manufacturer:	NOVO-TECH GmbH & Co. KG Siemensstraße 31 • 06449 Aschersleben • Germany Tel.: +49 (0) 3473 / 22503 - 0 Fax: +49 (0) 3473 / 22503 - 15

2.) Chemical Composition/Information about Components

Composition:	Cellulose	CAS-Nr.: 9004-34-6	30 – 40 %
	Hemicellulose	CAS-Nr.: 9025-53-2	18 – 24 %
	Lignin	CAS-Nr.: 9005-53-2	12 – 16 %
	HDPE	CAS-Nr.: 9002-88-4	10 – 40 %

3.) Possible Hazards

No risks to health and environment if used and handled appropriately.

4.) First Aid Measures

No special measures required.

5.) Fire Prevention Measures

Suitable extinguishing agents: Water spray, foam, CO₂, powder

6.) Measures in Case of Unintentional Release:

For people: No special measures required
Cleaning: Absorb mechanically (e.g. vacuuming)

7.) Handling and Storage

Storage: Smoking prohibited in storage area.
Fire protection measures: No open flame.
Handling: To avoid electrostatic discharges, the production and transport equipment should be made from electrically conductive material and be well earthed.
With thermal processing: Extract vapours and/or ensure working areas are sufficiently ventilated.

8.) Exposure Limit and Personal Protective Equipment

Work hygiene: Comply with general protective and hygiene measures: Always wash hands before eating, drinking, smoking or using the W.C..
General safety measures: Ensure that working areas are sufficiently ventilated and have adequate extraction systems.
Skin protection / Eye protection: Not required

9.) Physical and Chemical Properties

Form: Wood-polymer optics
Colours: Brown, black, multicoloured
Odour: Woody
pH value (with 100g/l H₂O and 20°C): 4.5 – 6.5
Melting point: Not applicable
Fire protection classification: Flame retardant material according to DIN EN 13501-1:2010, DIN EN 13501-1:2010, Classification normal: D_{fl}-s1 (old B2) Classification difficult: C_{fl}-s1
Boiling point (1013 hPa) / Flashpoint: Not applicable
Ignition point: Approx. 420°C (DIN 51 795)
Explosion limits: Not applicable
Migration: Toy fitness after DIN EN 71-3

TECHNICAL SAFETY INFORMATION HOLZART

Vapour pressure (20°C):	Not applicable
Density (20°C):	1,250kg/m ³
Solubility in water (20°C):	Insoluble
Product designation:	Polymer bonded wood material

10.) Stability and Reactivity

Stability:	Product is stable under normal conditions. Thermal decomposition starts at approx. 180°C.
Dangerous reactions:	None known.
Hazardous decomposition products:	Incomplete combustion releases carbon monoxide and possibly other hazardous substances such as soot, for example.

11.) Allergens

The product does not contain any of the 14 allergen materials that are subject to mandatory declaration in accordance with the EU Food Information Regulation 1169/2011.

12.) Toxicological Information

No damaging effects when handled appropriately.

13.) Ecological Information

The product is a wood polymer mixture insoluble in water with no negative environmental impact on ecosystems. Up to 75 % of the product is made from renewable resources.

14.) Disposal Notes

Recyclable take-back system via our dealers. Today's product is tomorrow's raw material. GCC is Cradle to Cradle Gold certified and valuable to dispose of. Return your GCC products at the end of their useful life to one of our take-back dealers. You can find them at www.megawood.com/en/dealers. Or register your item at www.megawood.com/en/c2c. We use the data exclusively for our take-back system and will contact you in due time to clarify the take-back.

15.) Transport Information

Not subject to mandatory labelling/markings acc. to Directive 67/548/EEC, the Hazardous Substances Ordinance (GefStoffV) and other rules and regulations. Not a hazard acc. to applicable transport rules and regulations.

16.) Wind load strain of terrace surfaces

Lifting loads caused by wind suction must be taken into consideration when dealing with terrace floorboards that are laid parallel to the supporting construction. Dead weight in combination with the respectively designed sub-construction must compensate for these lifting loads. Depending on the plank thickness and the associated sub-construction, no lifting of the planks is expected in normal areas. Prevention against lifting must be planned on the basis of the guidelines and standards in exposed terrace areas, in the event of special boundary conditions as well as in particularly high locations.

17.) Rules and Regulations

EEC marking:	Not subject to mandatory marking acc. to EEC rules and regulations.
Hazard symbols, R-phrases and S-phrases:	Not required
Water pollution class:	WPC 0 (not hazardous)

18.) Additional Information

The information supplied here corresponding with current findings, knowledge, and experiences, are to describe the product's safety aspects. However, this information is not associated with any warranty or guarantee of product properties. This product safety sheet was prepared according to the second revision of Directive 91/155/EEC based on Directive 2001/58/EU of the commission dated July 27, 2001.

This safety data sheet applies to the following: **megawood®** Polymer bonded wood material
Rev. Level: 07.11.2022

TECHNICAL SAFETY INFORMATION HARZART

1.) Material/Manufacturer Designation

Product designation:	megawood®
Material/substance type:	Polymer bonded wood material
Use:	Production of extruded profiles and injection moulding elements
Manufacturer:	NOVO-TECH GmbH & Co. KG Siemensstraße 31 • 06449 Aschersleben • Germany Tel.: +49 (0) 3473 / 22503 - 0 Fax: +49 (0) 3473 / 22503 - 15

2.) Chemical Composition/Information about Components

Composition:	Synthetic resin / minerals	20 - 30 %
	Cellulose CAS-Nr.: 9004-34-6	24 - 28 %
	Hemicellulose CAS-Nr.: 9025-53-2	15 - 17 %
	Lignin CAS-Nr.: 9005-53-2	10 - 11 %
	HDPE CAS-Nr.: 9002-88-4	10 - 30 %

3.) Possible Hazards

No risks to health and environment if used and handled appropriately.

4.) First Aid Measures

No special measures required.

5.) Fire Prevention Measures

Suitable extinguishing agents: Water spray, foam, CO₂, powder

6.) Measures in Case of Unintentional Release:

For people: No special measures required
Cleaning: Absorb mechanically (e.g. vacuuming)

7.) Handling and Storage

Storage: Smoking prohibited in storage area.
Fire protection measures: No open flame.
Handling: To avoid electrostatic discharges, the production and transport equipment should be made from electrically conductive material and be well earthed.
With thermal processing: Extract vapours and/or ensure working areas are sufficiently ventilated.

8.) Exposure Limit and Personal Protective Equipment

Work hygiene: Comply with general protective and hygiene measures: Always wash hands before eating, drinking, smoking or using the W.C..
General safety measures: Ensure that working areas are sufficiently ventilated and have adequate extraction systems.
Skin protection / Eye protection: Not required

9.) Physical and Chemical Properties

Form: Wood-polymer optics
Colours: Brown, black, multicoloured
Odour: Woody
pH value (with 100g/l H₂O and 20°C): 4.5 - 6.5
Melting point: Not applicable
Fire protection classification: Flame retardant material according to DIN EN 13501-1:2010, DIN EN 13501-1:2010, Classification normal: D_{fl}-s1 (old B2) Classification difficult: C_{fl}-s1
DIN EN 13501-1:2018-12, Classification difficult: B_{fl}-s1
Boiling point (1013 hPa) / Flashpoint: Not applicable
Ignition point: Approx. 420°C (DIN 51 795)
Explosion limits: Not applicable

TECHNICAL SAFETY INFORMATION HARZART

Migration:	Toy fitness after DIN EN 71-3
Vapour pressure (20°C):	Not applicable
Density (20°C):	1,350kg/m ³
Solubility in water (20°C):	Insoluble
Product designation:	Polymer bonded wood material

10.) Stability and Reactivity

Stability:	Product is stable under normal conditions. Thermal decomposition starts at approx. 180°C.
Dangerous reactions:	None known.
Hazardous decomposition products:	Incomplete combustion releases carbon monoxide and possibly other hazardous substances such as soot, for example.

11.) Allergens

The product does not contain any of the 14 allergen materials that are subject to mandatory declaration in accordance with the EU Food Information Regulation 1169/2011.

12.) Toxicological Information

No damaging effects when handled appropriately.

13.) Ecological Information

The product is a wood polymer mixture insoluble in water with no negative environmental impact on ecosystems. Up to 75 % of the product is made from renewable resources.

14.) Disposal Notes

Recyclable take-back system via our dealers. Today's product is tomorrow's raw material. GCC is Cradle to Cradle Gold certified and valuable to dispose of. Return your GCC products at the end of their useful life to one of our take-back dealers. You can find them at www.megawood.com/en/dealers. Or register your item at www.megawood.com/en/c2c. We use the data exclusively for our take-back system and will contact you in due time to clarify the take-back.

15.) Transport Information

Not subject to mandatory labelling/markings acc. to Directive 67/548/EEC, the Hazardous Substances Ordinance (GefStoffV) and other rules and regulations. Not a hazard acc. to applicable transport rules and regulations.

16.) Wind load strain of terrace surfaces

Lifting loads caused by wind suction must be taken into consideration when dealing with terrace floorboards that are laid parallel to the supporting construction. Dead weight in combination with the respectively designed sub-construction must compensate for these lifting loads. Depending on the plank thickness and the associated sub-construction, no lifting of the planks is expected in normal areas. Prevention against lifting must be planned on the basis of the guidelines and standards in exposed terrace areas, in the event of special boundary conditions as well as in particularly high locations.

17.) Rules and Regulations

EEC marking:	Not subject to mandatory marking acc. to EEC rules and regulations.
Hazard symbols, R-phrases and S-phrases:	Not required
Water pollution class:	WPC 0 (not hazardous)

18.) Additional Information

The information supplied here corresponding with current findings, knowledge, and experiences, are to describe the product's safety aspects. However, this information is not associated with any warranty or guarantee of product properties. This product safety sheet was prepared according to the second revision of Directive 91/155/EEC based on Directive 2001/58/EU of the commission dated July 27, 2001.

This safety data sheet applies to the following: **megawood®** Polymer bonded wood material
Rev. Level: 07.11.2022

FORMS OF DELIVERY AND PACKAGING UNITS

megawood® decking

gcc *HOLZart*

megawood® CLASSIC (21x145 mm)				package content 98 pcs.
Length in cm	running meter	kg/pcs.	sqm/pack	kg/pack
300	294.00	9.51*	42.63	931.98*
360	352.80	11.41*	51.16	1,118.38*
420	411.60	13.31*	59.68	1,304.77*
480	470.40	15.22*	68.21	1,491.17*
540	529.20	17.12*	76.73	1,677.56*
600	588.00	19.02*	85.26	1,863.96*

megawood® CLASSIC Jumbo (21x242 mm)				package content 56 pcs.
Length in cm	running meter	kg/pcs.	sqm/pack	kg/pack
420	235.20	24.36*	56.92	1,364.16*
480	268.80	27.84*	65.05	1,559.04*
600	336.00	34.80*	81.31	1,948.80*

megawood® PREMIUM (21x145 mm)				package content 84 pcs.
Length in cm	running meter	kg/pcs.	sqm/pack	kg/pack
420	352.80	14.66*	51.16	1,231.27*
480	403.20	16.75*	58.46	1,407.17*
600	504.00	20.94*	73.08	1,758.96*

megawood® PREMIUM Jumbo (21x242 mm)				package content 48 pcs.
Length in cm	running meter	kg/pcs.	sqm/pack	kg/pack
420	201.60	25.79*	48.79	1,237.82*
480	230.40	29.47*	55.76	1,414.66*
600	259.20	33.16*	62.73	1,591.49*

megawood® PREMIUM PLUS (21x145 mm)				package content 84 pcs.
Length in cm	running meter	kg/pcs.	sqm/pack	kg/pack
420	352.80	14.66*	51.16	1,231.27*
480	403.20	16.75*	58.46	1,407.17*
600	504.00	20.94*	73.08	1,758.96*

megawood® PREMIUM PLUS Jumbo (21x242 mm)				package content 48 pcs.
Length in cm	running meter	kg/pcs.	sqm/pack	kg/pack
420	201.60	26.21*	48.79	1,257.98*
480	230.40	29.95*	55.76	1,437.70*
600	288.00	37.44*	69.70	1,797.12*

* These weights are approximate. Production processes may vary these weights up to 5% of the guideline.

FORMS OF DELIVERY AND PACKAGING UNITS

megawood® decking

^{gcc}HOLZart

megawood® SIGNUM (21x145 mm)				package content 84 pcs.
Length in cm	running meter	kg/pcs.	sqm/pack	kg/pack
360	302.40	12.89*	43.85	1,082.59*
420	352.80	15.04*	51.16	1,263.02*
480	403.20	17.18*	58.46	1,443.46*
540	453.60	19.33*	65.77	1,623.89*
600	504.00	21.48*	73.08	1,804.32*

megawood® SIGNUM Jumbo (21x242 mm)				package content 48 pcs.
Length in cm	running meter	kg/pcs.	sqm/pack	kg/pack
360	172.80	22.32*	41.82	1,071.36*
420	201.60	26.04*	48.79	1,249.92*
480	230.40	29.76*	55.76	1,428.48*
540	259.20	33.48*	62.73	1,607.04*
600	288.00	37.20*	69.70	1,785.60*

megawood® decking

^{gcc}HARZart

megawood® DELTA (21x145 mm)				package content 70 pcs.
Length in cm	running meter	kg/pcs.	sqm/pack	kg/pack
420	294.00	17.01*	42.63	1,190.70*
480	336.00	19.44*	48.72	1,360.80*
600	420.00	24.30*	60.90	1,701.00*

megawood® CLASSIC Varia (21x195 mm)				package content 60 pcs.
Length in cm	running meter	kg/pcs.	sqm/pack	kg/pack
420	252.00	21.13*	49.14	1,267.56*
480	288.00	24.14*	56.16	1,448.64*
600	360.00	30.18*	70.20	1,810.80*

megawood® DYNUM (21x242 mm)				package content 48 pcs.
Length in cm	running meter	kg/pcs.	sqm/pack	kg/pack
420	201.60	26.75*	48.79	1,284.19*
480	230.40	30.58*	55.76	1,467.65*
600	288.00	38.22*	69.70	1,834.56*

megawood® DYNUM (25x293 mm)				package content 30 pcs.
Length in cm	running meter	kg/pcs.	sqm/pack	kg/pack
420	126.00	38.60*	36.92	1,157.94*
480	144.00	44.11*	42.19	1,323.36*
600	180.00	55.14*	52.74	1,654.20*

FORMS OF DELIVERY AND PACKAGING UNITS

megawood® decking

gcc **HOLZart**

megawood® sub construction (40x60 mm)				package content 170 pcs.
Length in cm	running meter	kg/pcs.	sqm/pack	kg/pack
360	612.00	9.29*	36.72	1,578.96*

megawood® sub construction (80x60 mm)				package content 68 pcs.
Length in cm	running meter	kg/pcs.	sqm/pack	kg/pack
400	272.00	12.32*	16.32	837.76*

megawood® connector (28x76 mm)				package content 52 pcs.
Length in cm	running meter	kg/pcs.	sqm/pack	kg/pack
360	187.20	3.78*	14.23	196.56*

megawood® decking

gcc **HOLZart**

	package content	Package dimensions	Unit	Forms of delivery
Board CLASSIC 21x145 mm	98 pcs. per 7 pcs. side by side, per 14 pcs. stacked	1,020x400 mm Length 300 to 600 cm	per 2 pcs. completely foil-covered	Per bundle on untreated square support boards; bundle straps and edge protectors
Board CLASSIC Jumbo 21x242 mm	56 pcs. per 4 pcs. side by side, per 14 pcs. stacked	1,020x400 mm Length 420 to 600 cm	per 1 pc. completely foil-covered	Per bundle on untreated square support boards; bundle straps and edge protectors
Board PREMIUM PREMIUM PLUS 21x145 mm	84 pcs. per 7 pcs. side by side, per 12 pcs. stacked	1,020x400 mm Length 300 to 600 cm	per 2 pcs. completely foil-covered	Per bundle on untreated square support boards; bundle straps and edge protectors
Board Jumbo PREMIUM PREMIUM PLUS 21x242 mm	48 pcs. per 4 pcs. side by side, per 12 pcs. stacked	1,020x400 mm Length 300 to 600 cm	per 1 pc. completely foil-covered	Per bundle on untreated square support boards; bundle straps and edge protectors
Board SIGNUM 21x145 mm	84 pcs. per 7 pcs. side by side, per 12 pcs. stacked	1,020x400 mm Length 360 to 600 cm	per 2 pcs. completely foil-covered	Per bundle on untreated square support boards; bundle straps and edge protectors
Board SIGNUM Jumbo 21x242 mm	48 pcs. per 4 pcs. side by side, per 12 pcs. stacked	1,020x400 mm Length 300 to 600 cm	per 1 pc. completely foil-covered	Per bundle on untreated square support boards; bundle straps and edge protectors

* These weights are approximate. Production processes may vary these weights up to 5% of the guideline.

FORMS OF DELIVERY AND PACKAGING UNITS

megawood® decking

^{gcc}HARZart

	package content	Package dimensions	Unit	Forms of delivery
Board DELTA 21 x 145 mm	70 pcs. per 7 pcs. side by side, per 5 pcs. stacked	1,020 x 310 mm Length 420 to 600 cm	per 2 pcs. completely foil-covered	Per bundle on untreated square support boards; bundle straps and edge protectors
Board CLASSIC Varia 21 x 195 mm	60 pcs. per 5 pcs. side by side, per 12 pcs. stacked	980 x 360 mm Length 420 to 600 cm	per 2 pcs. completely foil-covered	Per bundle on untreated square support boards; bundle straps and edge protectors
Board DYNUM 21 x 242 mm	48 pcs. per 4 pcs. side by side, per 12 pcs. stacked	1,020 x 400 mm Length 360 to 600 cm	per 1 pc. completely foil-covered	Per bundle on untreated square support boards; bundle straps and edge protectors
Board DYNUM 25 x 293 mm	30 pcs. per 3 pcs. side by side, per 10 pcs. stacked	880 x 350 mm Length 360 to 600 cm	per 1 pc. completely foil-covered	Per bundle on untre- ated square support boards; bundle straps and edge protectors

megawood® sub construction

^{gcc}HOLZart

	package content	Package dimensions	Unit	Forms of delivery
Sub construction 40 x 60 mm	170 pcs. per 17 pcs. side by side, per 10 pcs. stacked	1,020 x 500 mm Length 360 cm	per 2 pcs. partially foil-covered	Per bundle on untreated square support boards; bundle straps and edge protectors
Sub construction 80 x 60 mm	68 pcs. per 17 pcs. side by side, per 4 pcs. stacked	1,020 x 420 mm Length 400 cm	not foil-covered	Per bundle on untreated square support boards; bundle straps and edge protectors
Connector 28 x 76 mm	52 pcs. per 13 pcs. side by side, per 4 pcs. stacked	1010 x 210 mm Length 360 cm	1 piece each partially foiled	Per bundle on untreated square support boards; bundle straps and edge protectors

FORMS OF DELIVERY AND PACKAGING UNITS

megawood® decking

megawood® fastening	package content in packing units
Locking clamp, one-piece, blackened, 50 pcs. incl. 17 screws	48 pack
Locking clamp, one-piece, blackened, 250 pcs. incl. 85 screws	20 pack
Locking clamp edge, one-piece, blackened, 25 pcs./pack	24 pack
Clip, blackened, 50 pcs./pack	25 pack
Clip, blackened, 250 pcs./pack	24 pack
Clip, blackened, 500 pcs./pack	20 pack
Edge clip, blackened, 25 pcs./pack	25 pack
Locking clamp normal steel, one-piece, blackened, 50 pcs. incl. 17 screws	48 pack
Locking clamp normal steel, one-piece, blackened, 250 pcs. incl. 85 screws	20 pack
Locking clamp edge normal steel, one-piece, blackened, 25 pcs./pack	24 pack
Clip normal steel, blackened, 50 pcs./pack	25 pack
Clip normal steel, blackened, 250 pcs./pack	24 pack
Clip normal steel, blackened, 500 pcs./pack	20 pack
Edge clip normal steel, blackened, 25 pcs./pack	25 pack

megawood® accessories sub construction	package content in packing units
Sub construction fixing screws 7.5 x 92 mm incl. bit und drill	20 pack
Sub construction fixing screws 7.5 x 132 mm incl. bit und drill	10 pack
Self-adhesive retaining band 10 mm, 10 m/roll	25 roll
Groove bridge, 20 pcs./pack	20 pack

megawood® accessories	package content in packing units
Rubber pad 60x20x100 mm	100 pcs.
Rubber pad 60x10x100 mm	100 pcs.
Rubber pad 60x3x100 mm	100 pcs.
Distance keeper, mounting aid for decking, 10 pcs.	10 pack
Zammer, mounting aid for one-piece locking clamp	10 pcs.
Rolli, additional part for Zammer	10 pcs.
Screw M8 x 80 mm + washer + nut, 10 pcs./pack	25 pack
Screw M8 x 40 mm, 10 pcs./pack	25 pack
Screw M6 x 40 mm, 10 pcs./pack	10 pack
Screw set, 4 x 35 mm, 25 pcs./pack	1 pack
Distanz Fix, 10 pcs./pack	12 pack
Arretier Fix, 20 pcs./pack	12 pack

FORMS OF DELIVERY AND PACKAGING UNITS

megawood® decking

megawood® accessories profiles and strips	package content in packing units
Groove strip 21 mm, 25 m/roll	10 roll
Groove strip 21 mm, 100 m/roll	10 roll
Groove strip P5, 25 m/roll	10 roll
Groove strip P5, 100 m/roll	10 roll
Ventilation grilles, stainless steel brushed	54 pcs.
House connection profile 55.5 x 45.0 x 1,5 mm / 25 mm silver/anthracite anodised; Length 400 cm	10 pcs.
House connection profile 55.5 x 45.0 x 1,5 mm / 21 mm bronze/silver/anthracite anodised; Length 400 cm	10 pcs.
Gehrungsprofil, aluminium 50 x 25 mm bronze/silver/anthracite anodised; Length 400 cm	10 pcs.
Sealing tape for miter profile 20 mm, 13 m/roll	15 roll

megawood® VARIO FIX system

megawood® VARIO FIX I & II				
Art. no.	Name	kg/pcs.	pcs./pack	kg/pack
MWVFUK100000SW	VARIO FIX I	3.08*	200	546.60*
MWVFUK200000SW	VARIO FIX II	3.24*	200	648.00*

megawood® accessories VARIO FIX

megawood® accessories VARIO FIX	package content in packing units
Attachment piece elevated installation	80 pcs.
Comfort pad	80 pcs.
Rubber pad 300 x 300 x 3 mm	80 pcs.
Rubber pad 300 x 300 x 5 mm	80 pcs.
Rubber pad 300 x 300 x 10 mm	40 pcs.
Assembly clip, 10 pcs./pack	10 pack
Perforated tape, 10 m/roll	25 roll
Fastening screw for perforated tape 10 pcs.	1 pack

megawood® cleaning & care

megawood® cleaning & care	package content in packing units
Scouring powder, 2 Kg Tüte	8 pcs.
Scrubbing brush	1 pc.
Scrubbing brush incl. bracket and 2 wing screws	1 pc.
indoor protect 0.75 L	12 pcs.
indoor protect 2.5 L	8 pcs.

FORMS OF DELIVERY AND PACKAGING UNITS

megalite LED lighting system

megawood® LED lighting system	package content in packing units
LED-Linear light for horizontal installation, 27 W	6 pcs.
LED-Linear light for horizontal installation, 36 W	6 pcs.
LED-Linear light for horizontal installation, 45 W	6 pcs.
LED-Linear light for vertical installation, 27 W	6 pcs.
LED-Linear light for vertical installation, 36 W	6 pcs.
LED-Linear light for vertical installation, 45 W	6 pcs.
LED-Spot Mini	40 pcs.
LED-Spot Maxi	40 pcs.
2 box distributor	10 pcs.
4 box distributor	10 pcs.
Extension cables 1 m	20 pcs.
Extension cables 3 m	20 pcs.
Extension cables 6 m	10 pcs.
Power supply electronic ballast 40 W	5 pcs.
Power supply electronic ballast 150 W	5 pcs.
Repeater	5 pcs.
Remote control set	5 pcs.
LED bulb, 27 W	1 pc.
LED bulb, 36 W	1 pc.
LED bulb, 45 W	1 pc.
Cover profile for Linear light horizontal installation	1 pc.
Cover profile for Linear light vertical installation	1 pc.
Aluminium profile for Linear light	1 pc.
Aluminium end caps 2 pieces, + 4 stainless steel screws	1 pack

FORMS OF DELIVERY AND PACKAGING UNITS

megawood® LIMES fencing system

^{gcc}HOLZart

megawood® circular posts (Ø 90 mm)				package content 44 pcs.
Length in cm	running meter	kg/pcs.	sqm/pack	kg/pack
220	96.80	18.26*	8.71	803.44*
270	118.80	22.41*	10.69	986.04*

megawood® octagonal posts (90 x 90 mm)				package content 44 pcs.
Length in cm	running meter	kg/pcs.	sqm/pack	kg/pack
220	96.80	18.26*	8.71	803.44*
270	118.80	22.41*	10.69	986.04*

megawood® square posts (90 x 90 mm)				package content 44 pcs.
Length in cm	running meter	kg/pcs.	sqm/pack	kg/pack
220	96.80	21.12*	8.71	929.28*
270	118.80	25.92*	10.69	1,140.48*

megawood® oval posts (60 x 90 mm)				package content 44 pcs.
Length in cm	running meter	kg/pcs.	sqm/pack	kg/pack
220	96.80	12.98*	8.91	571.12*
270	118.80	15.93*	10.93	700.92*

megawood® LIMES fencing system

^{gcc}HARZart

megawood® panel Augusta (270 x 35 x 6 mm)				package content 84 pcs.
Length in cm	running meter	kg/pcs.	sqm/pack	kg/pack
160.2	134.57	5.13*	36.33	430.62*
180.5	151.62	5.78*	40.94	485.18*
210	176.40	6.72*	47.63	564.48*

megawood® panel Colonia (239 x 6 mm)				package content 84 pcs.
Length in cm	running meter	kg/pcs.	sqm/pack	kg/pack
158.4	133.06	2.79*	31.80	234.18*
210	176.40	3.70*	42.16	310.46*

* These weights are approximate. Production processes may vary these weights up to 5% of the guideline.

FORMS OF DELIVERY AND PACKAGING UNITS

megawood® LIMES fencing system

^{gcc}HOLZart

megawood® bar (40x112 mm)				package content 56 pcs.
Length in cm	running meter	kg/pcs.	sqm/pack	kg/pack
178.6	100.02	9.37*	11.20	524.68*

megawood® oval bar (60x90 mm)				package content 56 pcs.
Length in cm	running meter	kg/pcs.	sqm/pack	kg/pack
178.6	78.58	10.54*	7.23	463.65*

megawood® H-shaped profile bar (38x30 mm)				package content 96 pcs.
Length in cm	running meter	kg/pcs.	sqm/pack	kg/pack
156.6	150.34	1.82*	5.71	174.39*

megawood® H-shaped profile bar (38x30 mm)				package content 96 pcs.
Length in cm	running meter	kg/pcs.	sqm/pack	kg/pack
178.6	171.46	2.07*	6.52	198.89*
190	182.40	2.20*	6.93	211.58*

megawood® LIMES fencing system accessories	package content in packing units
Blackened bar connectors incl. M6 x 30 mm screws, 4 pcs./pack	28 pcs.
Stainless steel panel holder, 16 pcs./pack	12 pcs.
Base plate incl. 4 pcs. M8 x 80 mm screws (galvanised)	44 pcs.
6 x 40 mm stainless steel pin, 10 pcs./pack	12 pcs.
Internal hexagonal screw for H-shaped profile bar incl. bit, stainless steel, 16 pcs./pack	1 pcs.
Stainless steel bar	1 pcs.
Insert bar for stainless steel bar	1 pcs.
Assessories set for stainless steel bar	1 pcs.

megawood® LIMES fencing system

^{gcc}HOLZart

	package content	Package dimensions	Unit	Forms of delivery
Circular posts Ø 90 mm	44 pcs. per 11 pcs. side by side, per 4 pcs. stacked	1,110x440mm Length 220 cm and 270 cm	per 1 pc. completely foil-covered	Per bundle on untreated square support boards; bundle straps and edge protectors
Octagonal posts 90x90 mm	44 pcs. per 11 pcs. side by side, per 4 pcs. stacked	1,110x440mm Length 220 cm and 270 cm	per 1 pc. completely foil-covered	Per bundle on untreated square support boards; bundle straps and edge protectors

FORMS OF DELIVERY AND PACKAGING UNITS

megawood® LIMES fencing system

^{gcc}HOLZart

	package content	Package dimensions	Unit	Forms of delivery
Square posts 90x90 mm	44 pcs. per 11 pcs. side by side, per 4 pcs. stacked	1,030x450 mm Length 220 cm and 270 cm	per 1 pc. completely foil-covered	Per bundle on untreated square support boards; bundle straps and edge protectors
Oval posts 60x90 mm	44 pcs. per 11 pcs. side by side, per 4 pcs. stacked	1,030x450 mm Length 220 cm and 270 cm	per 1 pc. completely foil-covered	Per bundle on untreated square support boards; bundle straps and edge protectors
Bar 40x112 mm	56 pcs. per 8 pcs. side by side, per 7 pcs. stacked	900x360 mm Length 178.6 cm	per 1 pc. completely foil-covered	Per bundle on untreated square support boards; bundle straps and edge protectors
Oval bar 60x90mm	56 pcs. per 8 pcs. side by side, per 7 pcs. stacked	830x560 mm Length 178.6 cm	per 2 pcs. completely foil-covered	Per bundle on untreated square support boards; bundle straps and edge protectors
H-shaped profile bar 8 UNITS 38x30mm	96 pcs. per 6 pcs. side by side, per 4 pcs. stacked	960x220 mm Length 156.6 cm	per 4 pcs. completely foil-covered	Per bundle on untreated square support boards; bundle straps and edge protectors
H-shaped profile bar 38x30 mm	96 pcs. per 6 pcs. side by side, per 4 pcs. stacked	960x220 mm Length 178.6 cm and 190 cm	per 4 pcs. completely foil-covered	Per bundle on untreated square support boards; bundle straps and edge protectors

megawood® LIMES fencing system

^{gcc}HARZart

	package content	Package dimensions	Unit	Forms of delivery
Panel Augusta 270x35x6 mm	84 pcs. per 3 pcs. side by side, per 14 pcs. stacked	870x660 mm Length 270 cm	per 2 pcs. completely foil-covered	Per bundle on untreated square support boards; bundle straps and edge protectors
Panel Colonia 239x6 mm	84 pcs. per 4 pcs. side by side, per 3 pcs. stacked	960x250 mm Length 158.4 cm and 210 cm	per 7 pcs. completely foil-covered	Per bundle on untreated square support boards; bundle straps and edge protectors
Fence set with stainless steel bar 1,810x1,850mm	1 pc.	350x160 mm Length 195 cm	not foil-covered	Carton; Upper & lower woods, bundle straps and edge protectors

FORMS OF DELIVERY AND PACKAGING UNITS

megawood® LIMES fencing system

^{gcc}HARZart

megawood® LIMES panel Valeria (25 x 235 mm)				package content 64 pcs.
Length in cm	running meter	kg/pcs.	sqm/pack	kg/pack
193	123.52	7.28*	29.03	465.92*

megawood® LIMES posts (100 x 100 mm)				package content 30 pcs.
Length in cm	running meter	kg/pcs.	sqm/pack	kg/pack
220	66.00	19.60*	6.60	588.00*
270	81.00	24.06*	8.10	721.80*

megawood® LIMES insertion bar (6 x 34 mm)				package content 112 pcs.
Length in cm	running meter	kg/pcs.	sqm/pack	kg/pack
220	246.40	0.52*	8.38	58.24*

megawood® LIMES fencing system accessories		package content in packing units
post cap round		10 pcs.

megawood® LIMES fencing system

^{gcc}HARZart

	package content	Package dimensions	Unit	Forms of delivery
LIMES Panel Valeria 25 x 235 mm	64 pcs. per 4 pcs. side by side, per 8 pcs. stacked	940x500 mm Length 193 cm	per 2 pcs. completely foil-covered	Per bundle on untreated square support boards; bundle straps and edge protectors
LIMES posts 100x100 mm	30 pcs. per 10 Spcs.tück side by side, per 3 pcs. stacked	1,000x400 mm Length 220 cm and 270 cm	per 1 pc. completely foil-covered	Per bundle on untreated square support boards; bundle straps and edge protectors
LIMES insertion bar 6 x 34 mm	112 pcs. per 14 pcs. side by side, per 8 pcs. stacked	476 x 170 mm Length 220 cm	per 8 pcs. completely foil-covered	Per bundle on untreated square support boards; bundle straps and edge protectors, produce OSB board

megawood® accessories construction wood Rhombus		package content in packing units
Clamp for construction wood Rhombus, stainless steel, 30 pcs./pack		48 pack
Clamp for construction wood Rhombus, stainless steel, blackened, 30 pcs./pack		48 pack
Clamp for construction wood Rhombus, normal steel, blackened, 30 pcs./pack		48 pack

FORMS OF DELIVERY AND PACKAGING UNITS

megawood® construction wood system

^{ccc}HOLZart

megawood® construction plank (40 x 112 mm)				package content 56 pcs.
Length in cm	running meter	kg/pcs.	sqm/pack	kg/pack
360	201.60	18.89*	22.58	1,057.59*

megawood® construction plank (40 x 145 mm)				package content 49 pcs.
Length in cm	running meter	kg/pcs.	sqm/pack	kg/pack
420	205.80	28.56*	29.84	1,399.44*

megawood® circular construction wood (Ø 90 mm)				package content 44 pcs.
Length in cm	running meter	kg/pcs.	sqm/pack	kg/pack
360	158.40	29.88*	14.26	1,314.72*

megawood® octagonal construction wood (90 x 90 mm)				package content 44 pcs.
Length in cm	running meter	kg/pcs.	sqm/pack	kg/pack
360	158.40	29.88*	14.26	1,314.72*

megawood® square construction wood (90 x 90 mm)				package content 44 pcs.
Length in cm	running meter	kg/pcs.	sqm/pack	kg/pack
360	158.40	34.56*	14.26	1,520.64*

megawood® oval construction wood (60 x 90 mm)				package content 44 pcs.
Length in cm	running meter	kg/pcs.	sqm/pack	kg/pack
360	158.40	21.24*	14.57	934.56*

megawood® construction wood system

^{ccc}HARZart

megawood® construction wood Rhombus (20,5 x 81 mm)				package content 140 pcs.
Length in cm	running meter	kg/pcs.	sqm/pack	kg/pack
420	588.00	7.94*	49.00	1,111.3*

megawood® construction plank (40 x 112 mm) ingwer/sel gris/lorbeer				package content 56 pcs.
Length in cm	running meter	kg/pcs.	sqm/pack	kg/pack
360	201.60	18.89*	22.58	1,057.59*

megawood® construction plank (40 x 145 mm) ingwer/sel gris/lorbeer				package content 49 pcs.
Length in cm	running meter	kg/pcs.	sqm/pack	kg/pack
420	205.80	28.56*	29.84	1,399.44*

* These weights are approximate. Production processes may vary these weights up to 5% of the guideline.

FORMS OF DELIVERY AND PACKAGING UNITS

megawood® construction wood system

^{gcc}HOLZart

megawood® bench (690x960 mm)				package content 1 pc.
Length in cm	running meter	kg/pcs.	sqm/pack	kg/pack
180	-	87.00*	-	87.00*

megawood® plant container (1,000x810 mm)				package content 1 pc.
Length in cm	running meter	kg/pcs.	sqm/pack	kg/pack
110	-	215.00*	-	215.00*

megawood® sandpits 1 x hexagonal (1,200 x300 mm)				package content 1 pc.
Length in cm	running meter	kg/pcs.	sqm/pack	kg/pack
120	-	45.00*	-	45.00*

megawood® sandpits 2 x hexagonal (1,200 x300 mm)				package content 1 pc.
Length in cm	running meter	kg/pcs.	sqm/pack	kg/pack
210	-	75.00*	-	75.00*

megawood® sandpits 3 x hexagonal (2,100 x300 mm)				package content 1 pc.
Length in cm	running meter	kg/pcs.	sqm/pack	kg/pack
210	-	90.00*	-	90.00*

megawood® door (1,020x1,850 mm)				package content 1 pc.
Length in cm	running meter	kg/pcs.	sqm/pack	kg/pack
185	-	39.60*	-	39.60*

megawood® frame (1,120 x2,000 mm)				package content 1 pc.
Length in cm	running meter	kg/pcs.	sqm/pack	kg/pack
200	-	47.00*	-	47.00*

	package content	Package dimensions	Unit	Forms of delivery
Bench 69x960 mm	1 pc.	690 x240 mm Length 180 cm	not foil-covered	Per bundle on untreated square support boards;
Plant container 1,000 x1,000 mm	1 pc.	1,100 x1,100 mm Length 81 cm	not foil-covered	bundle straps and edge protectors
Sandpits 1x hexagonal 2x hexagonal 3x hexagonal	1 pc.	600 x450 mm Length 80 cm	not foil-covered	Inka pallet; carton; bundle straps and edge protectors
Door, no filling 1,020 x1,850 mm	1 pc.	200 x1,020 mm Length 185 cm	not foil-covered	Per bundle on untreated square support boards;
Frame 1,120 x2,000 mm	1 pc.	400 x1,120 mm Length 200cm	not foil-covered	bundle straps and edge protectors

CERTIFICATE

CRADLE TO CRADLE



Within these categories, our GCC wood-based panel has been certified according to *Cradle to Cradle Certified®**:

	BRONZE	SILVER	GOLD	PLATINUM
Material Health			✓	✓
Material Reutilization			✓	
Renewable Energy			✓	
Water Stewardship			✓	
Social Fairness			✓	

Cradle to Cradle® describes a materials cycle in which the products or raw materials respectively, permanently circulate in recurring cycles “from the cradle to the cradle“. At megawood®, the wooden GCC (German Compact Composite) products pass through a technical cycle so that they can always be used for the manufacturing of new products.

* Version 3.1, renewal 27 Aug 2024, GCC HARZart is currently in the certification process.
 More information on certification available at www.megawood.com/en/material/cradle-to-cradle-c2c
 Cradle to Cradle Certified® is a registered brand of the Cradle to Cradle Products Innovation Institute.



NOVO-TECH GmbH & Co. KG

has successfully achieved Cradle to Cradle Certified® Gold for the product(s) under the name:

German Compact Composite, GCC

megawood®, EasyDeck®, torroTIMBER®

Certification Number
5806

Standard Version
3.1

Lead Assessment Body
EPEA GmbH - Part of Drees & Sommer

Material Health Assessment Body
EPEA GmbH - Part of Drees & Sommer

Effective Date
21 December 2022

Expiration Date
27 August 2024

Susan Klosterhaus, Ph.D.
 Vice President, Science and Certification
 Cradle to Cradle Products Innovation Institute

See the Cradle to Cradle Certified Product Registry at www.c2ccertified.org for additional details.
 Use of the certification marks is subject to the terms and conditions of the C2CPII Certification Agreement and Trademark Use Guidelines.
 Cradle to Cradle Certified is a registered trademark of the Cradle to Cradle Products Innovation Institute.

cradle to cradle
**products
 innovation
 institute**

CERTIFICATE

PEFC

ZERTIFIKAT CERTIFICATE



Die HW-Zert GmbH, von PEFC Deutschland e. V. anerkannt und notifiziert, bestätigt hiermit, dass das Unternehmen

NOVO-TECH Trading GmbH & Co. KG

Siemensstraße 31
06449 Aschersleben

ein betriebliches Kontrollsystem unterhält, das mit den



PEFC
PEFC/04-31-1231

Chain-of-Custody-Anforderungen von PEFC

Programme for the Endorsement of Forest Certification gemäß des deutschen Standards PEFC D 1003:2013 "Produktkettennachweis für Holzprodukte - Anforderungen" *Deutsche Übersetzung des Internationalen PEFC- Standards PEFC ST 2002:2013* in der aktuell gültigen Fassung (siehe hierzu auch www.pefc.org) übereinstimmt.

Es wurde nachgewiesen, dass die Anforderungen bezüglich der

Methode der physischen Trennung

erfüllt sind und angewendet werden. Das Unternehmen hat mit der HW-Zert GmbH einen Begutachtungsvertrag abgeschlossen und wird jedes Jahr auditiert. Dieses Zertifikat berechtigt dazu, die im Geltungsbereich benannten Produkte/Produktgruppen nach der o. g. Methode als **PEFC-zertifiziert** und/oder **PEFC kontrollierte Quellen** zu verkaufen.

Art des Zertifikates:	Einzelzertifikat
PEFC-Scope:	Others
Geltungsbereich:	Produkte aus Holz-Polymer-Werkstoffen

Registriernummer HW-Zert GmbH:	HW-CoC-0354-19
Datum der Ausstellung:	15.05.2019
Dieses Zertifikat ist gültig:	01.06.2019 bis 31.05.2024

Horst Gleißner
Geschäftsführer

Wilfried Stech
Geschäftsführer



Deutsche
Akkreditierungsstelle
D-ZE-18039-01-00

HW-Zert GmbH • Gallersberg 10 • 85395 Attenkirchen
www.hw-zert.de • info@hw-zert.de



Die HW-Zert ist notifiziert in Belgien, Dänemark, Deutschland, Finnland, Frankreich, Großbritannien, Irland, Italien, Kanada, Malaysia, Niederlande, Österreich, Polen, Portugal, Schweden, Schweiz, Slowakei, Slowenien sowie über PEFC international in allen Ländern ohne eigenes PEFC-System.



ANLAGE zum PEFC-CoC-Zertifikat der HW-Zert GmbH
Nummer HW-CoC-0354-19 vom 15.05.2019

bezüglich der Chain-of-Custody-Anforderungen von PEFC
für das Unternehmen

NOVO-TECH Trading GmbH & Co. KG

Siemensstraße 31
06449 Aschersleben

Das Zertifikat umfasst neben der o. g. Zentrale folgende Organisationsteile:

ERFURT.SASSE Industry Holding GmbH & Co. KG

Siemensstraße 29
06449 Aschersleben

NOVO-TECH GmbH & Co. KG

Siemensstraße 31
06449 Aschersleben

Dieses Zertifikat ist gültig bis:

31.05.2024

Horst Gleißner
Geschäftsführer

Wilfried Stech
Geschäftsführer



HW-Zert GmbH • Gallersberg 10 • 85395 Attenkirchen
www.hw-zert.de • info@hw-zert.de



CERTIFICATE

Seal of quality - exemplary*

QUALITÄTSGEMEINSCHAFT HOLZWERKSTOFFE E.V.

CERTIFICATE

2022 – 14-1
for WPC-decking profiles

The decking profile of type

megawood CLASSIC

kind of profile	solid	based on	PE
thickness/width	21 x 145 mm	content of natural fibre	W>55, R<20

of the manufacturer

**NOVO-TECH GmbH & Co. KG,
06449 Aschersleben, Germany**

confirms with his testing results of the external supervision, done by the independent and certified institute

**Entwicklungs- und Prüflabor Holztechnologie GmbH (EPH),
Zellescher Weg 24, 01217 Dresden, Germany**

and the initial inspection of factory and the supervision of factory production control, done by the Qualitätsgemeinschaft Holzwerkstoffe e. V., Schumannstr. 9, 10117 Berlin (Germany) the requirements according the quality and testing criteria for decking profiles of Wood-Polymer-Composites (dated 1st March 2017).

The manufacturer is entitled to use the quality label.



Wood-Polymer-Composites of certified production

- **Wood** from sustainable forestry
- **Rice husk** from controlled farming
- Pure **industrial Polymer**

megawood - QG/2010/Z14, PE

Validity of the certificate is 12 months and so long as the quality criteria are not changed and the fulfilment of these criteria by the manufacturer is given.

Berlin, December 19th 2022

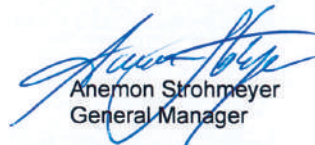
Anemon Strohmeier
General Manager

Qualitätsgemeinschaft Holzwerkstoffe e.V. • Schumannstr.9 • 10117 Berlin • Germany
Telefon +49 (0) 30 28 09 12 50 • info@qg-holzwerkstoffe.de

CERTIFICATE

Certificate solid boards - exemplary*



Entwicklungs- und Prüflabor
Holztechnologie GmbH

Zellescher Weg 24 · D-01217 Dresden

www.eph-dresden.de

Durch die Deutsche Akkreditierungsstelle GmbH (DAkkS)
nach DIN EN ISO/IEC 17025 akkreditiertes Prüflaboratorium



Deutsche
Akkreditierungsstelle
D-PL-11054-01-00

PRÜFUNGSZEUGNIS

CT-13-01-07-01

- Produkt:** Megawood Massivdiele, grau
- Firma:** NOVO-TECH GmbH & Co. KG
Siemensstraße 31
06449 Aschersleben
- Auftrag:** Bestimmung des Migrationsverhaltens von Schwermetallen nach
DIN EN 71-3
- Prüfmethodik:** Extraktion mit salzsaurem Wasser
Chemische Analyse: MP-AES (Mikrowellenplasma induzierte
Atomemissionsspektrometrie)
- Prüfbericht:** 152013/1 vom 20. Dezember 2012
- Prüfergebnis:** Das Produkt „Megawood Massivdiele, grau“ erfüllt sicher die
nach DIN EN 71-3 gestellten Anforderungen hinsichtlich der
Konzentrationen eluierbarer Schwermetalle (As, Sb, Ba, Cd, Cr,
Pb, Hg und Se).

Dresden, 07. Januar 2013

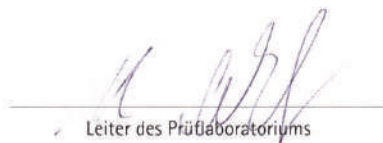
Leiter des Prüflaboratoriums

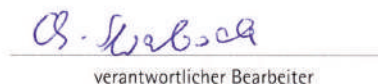

verantwortlicher Bearbeiter

TEST REPORT

Determination of the anti-slip property

PRÜFEN · ÜBERWACHEN · ZERTIFIZIEREN

BAUSTOFFPRÜFSTELLE Wismar GmbH



BAUSTOFFPRÜFSTELLE Wismar GmbH · LÜBSCHÉ STRASSE 109 · 23966 WISMAR

NOVO - TECH GmbH & Co. KG

Siemensstraße 31
GER-06449 Aschersleben

Wismar, 25.04.2017(V)
our signature: Sü./St./Vo.

Test report no.:	0595/17-V
Customer:	NOVO - TECH GmbH
Subject matter:	Testing accordance - Determination of the anti-slip properties - wet loaded barefoot areas according to DIN 51097 - 1992:11 - Determination of the anti-slip property - Workrooms and fields of activities with slip danger, walking method - Ramp test according to DIN 51130:2014-02 - Determination of the displacement space to DIN 51130:2014-02
Subject date:	10.04.2017
Samples received:	12.04.2017
Test date:	13.04.2017
Name of the product:	megawood deck board Classic Jumbo solid - grooved Dimensions l/w/h [cm]: 1000 x 242 x 21
Number of samples:	2,5 tiles
Origin:	as customer
Sampling:	The samples were provided by the customer.

The test report comprises 3 pages.

This test report replaces the test report-No. 0595/17 of 18.04.2017.

The test report is valid for 5 years, unless there are conditions that may change the surface condition.

Evidential samples shall only be stored for 2 months.

• Durch die DAKKS nach DIN EN ISO/IEC 17025 akkreditiertes Prüflaboratorium. Die Akkreditierung gilt nicht für die mit (*) gekennzeichneten
• Prüfverfahren. Bewertungen unterliegen nicht der Akkreditierung. Die Prüfergebnisse beziehen sich ausschließlich auf die untersuchten
• Prüfgegenstände. Der Prüfbericht darf ohne Genehmigung der BAUSTOFFPRÜFSTELLE Wismar GmbH nicht auszugsweise vervielfältigt,
• an Dritte weitergeleitet oder veröffentlicht werden.

ANSCHRIFT: Lübsche Straße 109, 23966 Wismar TELEFON: +49 (0)3841 76 23 06 TELEFAX: +49 (0)3841 76 30 76 E-MAIL:
info@bps-wismar.de INTERNET: www.bps-wismar.de AMTSGERICHT SCHWERIN HRB 1958 STEUER-NR. 080/166/00090
USt-Id-Nr. DE 137436034 GESCHÄFTSFÜHRUNG: Dipl.-Ing. Ellen Stolze



TEST REPORT

Determination of the anti-slip property

Baustoffprüfstelle Wismar GmbH
Lübsche Straße 109, 23966 Wismar
Tel.: 0 38 41 / 76 23 06; FAX: 0 38 41 / 76 30 78

Page: 2
of the test report no.: 0595/17-V

1. Determination of the anti-slip property according to DIN 51130:2014-02 "Determination of the anti-slip property - Workrooms and fields of activities with slip danger - Walking method - Ramp test" and
Determination of the anti-slip properties according to DIN 51097:1992-11 "Determination of the anti-slip properties - wet-loaded barefoot areas - walk method - ramp test"

Description of the panel:

colour/layout: grey surface: trapezoid corrugated

Preparation of the test cover:

A test cover, size 100 x 60 cm was produced by laying on a self-supporting, non-warping panel.

The width of a joint amounted to 3 mm.

The cover was cleaned with a dry cloth before the start of the test.

Mean angle of inclination:

Test no.	Corrected overall angle of acceptance DIN 51 130 increased skid risk [°]	angle of inclination DIN 51097 wet-loaded barefoot areas [°]
1	29,4	42,3
2	29,1	43,0
3	29,5	42,0
4	28,5	42,9
5	27,4	41,8
6	27,6	42,8
7	-	42,4
8	-	41,2
Mean value	28,6	42
Mean angle of inclination for assesment group shown below:	> 27 - 35	> 24

Assessment group:

In accordance with the test results obtained pursuant to the guidelines of DIN 51130 the tiles are to be classified in assessment group **R 12**.

In accordance with the test result obtained pursuant to the guidelines of DIN 51097 the natural stone tiles are to be classified in assessment group **C**.

TEST REPORT

Determination of the anti-slip property

Baustoffprüfstelle Wismar GmbH
Lübsche Straße 109, 23966 Wismar
Tel.: 0 38 41 / 76 23 06; FAX: 0 38 41 / 76 30 78

Page: 3
of the test report no.: 0595/17-V

2. Determination of the displacement space to DIN 51130:2004-06 "Determination of the anti-slip properties - working rooms and working areas with an increased skid risk - walk test - inclined plane"

Mean angle of inclination:

Test no.	Surface-related least volume of the displacement space
1	8,2
2	7,5
3	8,1
4	8,1
5	7,7
Mean value	8,0



Dipl.-Ing. (FH) Ch. Schümer
Official in Charge



Dipl.-Ing. E. Steige
Director of the Test Office

OVERVIEW

anti-slip properties and fire behaviour

Summary of the anti-slip properties and fire behaviour of the megawood® barefoot boards

GCC <i>HOLZart</i>	Anti-slip pursuant to standard DIN 51130 (R classes)	Fire behaviour** pursuant to DIN 13501-1
Board CLASSIC* 21 x 145 mm	 conforms with R 12	 normal flammability Dfl-s1
Board CLASSIC Jumbo* 21 x 242 mm	 conforms with R 12	 normal flammability Dfl-s1
Board SIGNUM* 21 x 145 mm	 conforms with R 10	 normal flammability Dfl-s1
Board SIGNUM* 21 x 242 mm	 conforms with R 10	 normal flammability Dfl-s1
Board PREMIUM* 21 x 145 mm	 conforms with R 11	 normal flammability Dfl-s1
Board Jumbo PREMIUM* 21 x 242 mm	 conforms with R 11	 normal flammability Dfl-s1
Board PREMIUM PLUS* 21 x 145 mm	 conforms with R 11	 flame retardant Cfl-s1
Board Jumbo PREMIUM PLUS* 21 x 242 mm	 conforms with R 11	 flame retardant Cfl-s1

GCC <i>HARZart</i>	Anti-slip pursuant to standard DIN 51130 (R classes)	Fire behaviour** pursuant to DIN 13501-1
Board DELTA* 21 x 145 mm	 conforms with R 12	 flame retardant Bfl-s1
Board CLASSIC Varia* 21 x 195 mm	 conforms with R 10	 flame retardant Cfl-s1
Board DYNUM* 21 x 242 mm	 conforms with R 10	 flame retardant Cfl-s1
Board DYNUM* 25 x 293 mm	 conforms with R 10	 flame retardant Cfl-s1

* All of the test reports are available by request.

** It is stipulated in the federal state building regulations that floor coverings in required stairwells, corridors and therefore also balconies and pergolas that serve as primary or secondary escape routes are to be made of hardly inflammable building materials (fire class Cfl-S1) as a minimum. The hardly inflammable boards can be used as floor coverings in primary and secondary escape routes in building regulation terms! The respective fire prevention concepts are to be inspected.

CERTIFICATE

Classification of fire behavior



Klassifizierungsbericht

Classification report

Nr.: **2714232**
No.:

Entwicklungs- und Prüflabor
Holztechnologie GmbH
Zellescher Weg 24
01217 Dresden

Tel.: +49 351 4662 0
Fax: +49 351 4662 211
info@eph-dresden.de
www.eph-dresden.de

Klassifizierung zum Brandverhalten gemäß DIN EN 13501-1:2010

Reaction to fire classification according to DIN EN 13501-1:2010

Auftraggeber (AG): NOVO-TECH GmbH & Co. KG
Client: Siemensstraße 31
06449 Aschersleben

Hersteller: siehe Auftraggeber
Manufacturer: cf. client

Produktname: megawood® Classic Barfußdiele, WPC-Terrassendiele massiv; 21 mm
Name of product: megawood® Classic barefoot board, massive WPC decking board; 21 mm
Bodenbelag für den Außenbereich / Floor covering for exterior use

Klassifikation: **Dfl-s1**
Classification:

Geltungsdauer: k. A.
Validity: n/s

Ausgabe-Nr.: 1. Ausfertigung / Original
Issue-No.: Original

Datum der Ausgabe: 26.06.2014
Date of issue:

Auftragnehmer (AN): Entwicklungs- und Prüflabor Holztechnologie GmbH - EPH
Contractor: Laborbereich Oberflächenprüfung
Development and Examination Laboratory for Wood Technology Ltd. - EPH
Laboratory Surface Testing

Notifizierte Stelle – Nr.: 0766
Notified body - No.:

Verantw. Bearbeiter: Dipl.-Ing. Ch. Kniest
Engineer in charge:

Dr. - Ing. R. Emmler
Leiter Laborbereich Oberflächenprüfung / Head of Laboratory Surface Testing

Der Klassifizierungsbericht umfasst 4 Seiten. Jede auszugsweise Vervielfältigung bedarf der schriftlichen Genehmigung des EPH. Die Prüfergebnisse beziehen sich ausschließlich auf die geprüften Materialien. Dieser Bericht ist zweisprachig. Im Zweifel gilt der deutsche Wortlaut.

The classification report contains 4 pages. Any duplication, even in part, requires written permission of EPH. These test results are exclusively related to the tested material. This report has been issued bilingually. In case of doubt, the German version is valid.

Geschäftsführer
Dr.-Ing. Bernd Devantier
Amtsgericht Dresden HRB 8072
USt-IdNr. DE 21 60 77 44 5

Commerzbank AG
SWIFT: DRES DE 33 050
IBAN: DE 13 8508 0000 0400 2982 00



CERTIFICATE

Classification of fire behavior



Branch office Erwitte • Auf den Thronen 2 • D-59597 Erwitte • Tel. (0 29 43) 8 97-0 • Fax (0 29 43) 8 97-33 • email: erwitte@mpanrw.de

Report of the classification of the reaction to fire behaviour

No 230010960-2
of 1 June 2017

English Version

Customer: NOVO-TECH GmbH & Co. KG
Siemensstraße 31

06449 Aschersleben

Order: Reaction to fire classification according to DIN EN 13501-1

Date of order: 2 March 2017

Designation of the building product to be classified:

Decking board flooring referred to as "Megawood Litum Steinholzplatte"

This report determines the classification of the above-mentioned building product in accordance with the method specified in DIN EN 13501-1.

Publishing and copying of classification reports without permission of MPA NRW is only allowed without any changes of the content and the form of the reports.
This classification report consists of 3 pages.

CERTIFICATE

Classification of fire behavior

1 Description of the building product

The building product designated "Megawood Litum Steinholzplatte" is decking board flooring with the following structure:

The decking boards are about 20 mm thick and consist of a wood-polymer material with stone granules. They have a metre weight of approx. 6.1–7.9 kg/metre. The surface is ridged on one side and the underside is smooth. The decking boards must be laid on Powolit construction beams.

2 Test reports and test results on which the classification is based

2.1 Test reports

Name of laboratory	Customer	Test report number	Test method
MPA NRW	NOVO-TECH GmbH & Co. KG	230010960-1 of 1 June 2017	EN ISO 9239-1 EN ISO 11925-2 (15 s flame resistance)

2.2 Test results

Test method	Parameter	Number of tests	Test results	
			Mean values	Requirement fulfilled
DIN EN ISO 11925 15 s B flame resistance	Flame propagation ≤ 150 mm	6	--	Yes
DIN EN ISO 9239-1	Critical heat flow (kW/m ²)	3	5.5	--
	Smoke (%xmin)	3	191	--

CERTIFICATE

Classification of fire behavior



Classification Report No. 230010960-2 of 1 June 2017

Page 3 of 3

3 Classification and direct field of application

3.1 Reference

The classification was carried out in conformity with clauses 12 and 14.2 of the standard DIN EN 13501-1:2010.

3.2 Classification

The classification assigned to the material with regard to its reaction to fire: **C_{fl}**

The additional classification with regard to smoke production: **s1**

This results in the following reaction to fire classification of the flooring:

Reaction to fire	Smoke production
C_{fl}	s1

i.e. **C_{fl} – s1**

3.3 Field of application of the product

The classification is valid solely for the building product described in Section 1 when used as flooring, laid horizontally – glued or not glued – on a base in Euro classes A1 or A2 in accordance with DIN EN 13501-1 with a raw density of at least 1,350 kg/m³ and a thickness of at least 6 mm.

4 Restrictions

This test report does not replace any type approval or certification of the product. This test report written in English language is issued additionally to the report written in German language with the same report number. In case of doubt the German version is solely valid.

Erwitte, 1 June 2017

Dipl.-Ing. Schreiner
(Deputy Head of the testing body)



(Dipl.-Ing. Olaf Rickert)

Date of issue of this English version: 2 December 2019

CERTIFICATE

Classification of fire behavior

ENVIRONMENTAL PRODUCT DECLARATION

as per ISO 14025 and EN 15804+A1

Owner of the Declaration	Verband der Deutschen Holzwerkstoffindustrie e.V. (VHI)
Programme holder	Institut Bauen und Umwelt e.V. (IBU)
Publisher	Institut Bauen und Umwelt e.V. (IBU)
Declaration number	EPD-VHI-20210249-IBE1-EN
Issue date	25.03.2022
Valid to	24.03.2027

WPC decking profiles

Verband der Deutschen

Holzwerkstoffindustrie e.V. (VHI)

Association of the German Wood-based Panel
Industry



Überreicht durch das VHI-Mitgliedsunternehmen
NOVO-TECH GmbH & Co. KG
Siemensstraße 31, 06449 Aschersleben
www.megawood.de



www.ibu-epd.com | <https://epd-online.com>



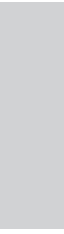



INTERACTIVELY EXPERIENCE megawood®

From the sub-construction to the decking board: Simply position marker on the point you would like to build your deck, scan it with your smartphone or tablet, and experience your new deck live and in 3D.

YOUR DEALER

